

NOVA541

Program Controller SP541

User's Manual

Limitations in use

This product was designed and manufactured for general industrial equipments. Special cares on safety is required in the case of using in following equipments. Users should take precautionary measures on Fail Safe design, periodical checkup, safety of the whole system.

- Safety Devices for protecting human body.
- Direct control of vehicles (navigation, run and stop)
- Airplanes
- Self-control Equipments
- Nuclear Power Equipments

Do not use for any purpose which affects the human body.

Thank you very much for the purchase of SP541 PROGRAM CONTROLLER.

This User's Manual explains the Installation and Operation Procedures.

The safety considerations and the right way of use are also included in it. A designer of the control panel, an Engineer of maintenance and users should read it and understand the necessary items before use.

This manual is also necessary for repairing, trouble shooting as well as an installation.

Keep it near at hand and use it as a reference.

Important Safety Guide

To prevent an accident of injury, All the Installers and users should keep the safety rules in this manual.

SAFETY SYMBOL MARKS

- (A) “Handle with Care” , “Precaution” : The operator must read and keep in mind the explanation because it is critical to protect a person or an instrument.



(1) On Product : The essential items the operator should know to prevent accidental injury or damage of the instrument.

(2) In User’s Manual : For the precautions necessary to prevent an accidental electric shock.

- (B) “Protective Ground Terminal”



Prior to operating, the terminal must be connected to the Ground.

- (C) “Supplementary Explanations”



Additional information on the operation and features of the product

- (D) “Reference Information”



Further information on the current topic and pages to refer

Precautionary Remarks on this User’s Manual



(1) This manual should be passed on the end user and kept at a suitable place for easy review.

(2) Before using the product, the operator should read this book carefully and understand the operation procedure.

(3) This manual describes the functions of the product in detail. Samwontech does not

warrant that the functions will suit a particular purpose which is not described in this manual.

- (4) Without permission, the contents of this manual cannot be transcribed or copied in part or wholly.
- (5) The contents of this manual may be modified without previous notice.
- (6) If any errors or omissions in this manual should come to the attention of the user, feel free to contact our sales representatives or our sales office.

Regarding Safety and Unauthorized Modification



- (1) For the protection and safe use of the product and relevant system, all of the safety instructions and precautions are well recognized and strictly observed by all users.
- (2) Samwontech does not guarantee safety if the product is not handled according to this manual.
- (3) If additional safety circuits for protection of system is required, Install them at outside of this product not at inside.
- (4) Don't try to disassemble, repair, or modify the product. It may become the cause of a trouble such as malfunction, electric shock, fire.
- (5) When part replacement or consumables are needed, call to our sales office.
- (6) Keep this product from moisture. It may become a cause of trouble.
- (7) Be careful not to apply any shock or vibration to the product. It may cause damage or malfunction.

Regarding an exemption from responsibility



- (1) Samwontech co., Ltd does not make any warranties regarding the product except Warranty conditions which mentioned in this manual.
- (2) Samwontech assumes no liability to any party for any loss or damage, direct or indirect, caused by the use or any unpredictable defect of the product.

Regarding the Production Quality Assurance



- (1) The guaranteed period of the production quality assurance is one year after end use by it and it will be free of charge to fix defective product under regular usage described in this manual.
- (2) The fixing cost will be charged for defective product after warranty period. This charge will be the actual cost of the fixing estimated by Samwontech.
- (3) It will be charged even if within warranty period for following cases.
 - (a) Defect by an operator or the user's default. (Initialize the product, forget password)
 - (b) Natural disaster (fire, flood)
 - (c) Additional shift after the first installation
 - (d) Improperly repaired, altered, or modified by the user.
 - (e) Power failure by unstable power supply
- (4) If any A/S is required, feel free to contact our sales office or a representative.

Precautions on Environment and Installations

Environmental Precautions



- (1) Be sure to power on and operate the controller after installation on a panel to prevent electric shock.
- (2) Do not install the controller at following places or environment
 - Anybody may touch the terminal inadvertently
 - Mechanical vibration or shock
 - Corrosive gas or combustible gas
 - Temperature fluctuation
 - Too hot (> 50°C) or Cold (< 10°C)
 - Direct rays of light or heat radiation
 - Magnetic or electromagnetic noise
 - High humidity (> 85%)
 - Flammable materials
 - Wind blow, Dust with salt
 - Ultra violet rays

Precautions on Controller Mounting



- (1) Keep the controller away from possible noise sources.
- (2) Keep the controller in 10~50°C, 20~90%RH (non condensing) and be careful not to expose heat generating sources.
- (3) Do not mount with a position that the front panel facing downward
- (4) Storage should be within -25~70°C, 5~95%RH (non condensing). At a cold condition below 10°C, sufficient warming-up should be preceded by the control operation.

- (5) Turn off the main power of the control unit before wiring to prevent electric shock.
- (6) The power rating of the controller is 10 VA max. at 100~240VAC, 50/60Hz. Be sure to use suitable power source to prevent overheating or electric shock.
- (7) Do not work with wet hands to prevent electric shock.
- (8) The precautions and procedures in the manual should be kept to avoid a hazard such as fire, injury, and electric shock.
- (9) Installation and Operation procedures should be done just as in this manual.
- (10) Make the grounding connection according to the way in manual. Do not use a tap water piping, a gas pipe, a telephone line, a lightning rod to avoid possible accidents such as explosion or inflammation.
- (11) Do not power on the controller before the wiring procedure is not completed.
- (12) Do not block or wrap the heat vent holes in the case of the controller. That may cause a failure. Air gaps greater than 50 mm is necessary on the upper and bottom sides of the controller.
- (13) Over-voltage protection category II and Pollution Degree II are rated for the controller.

Engineering Units – EU, EUS

- ▶ EU and EUS are used for the scaling of the parameters of the controller.

☞ EU() : The Range of the Instrument, Engineering Unit

☞ EUS() : The Range of the span of the Instrument, Engineering Unit

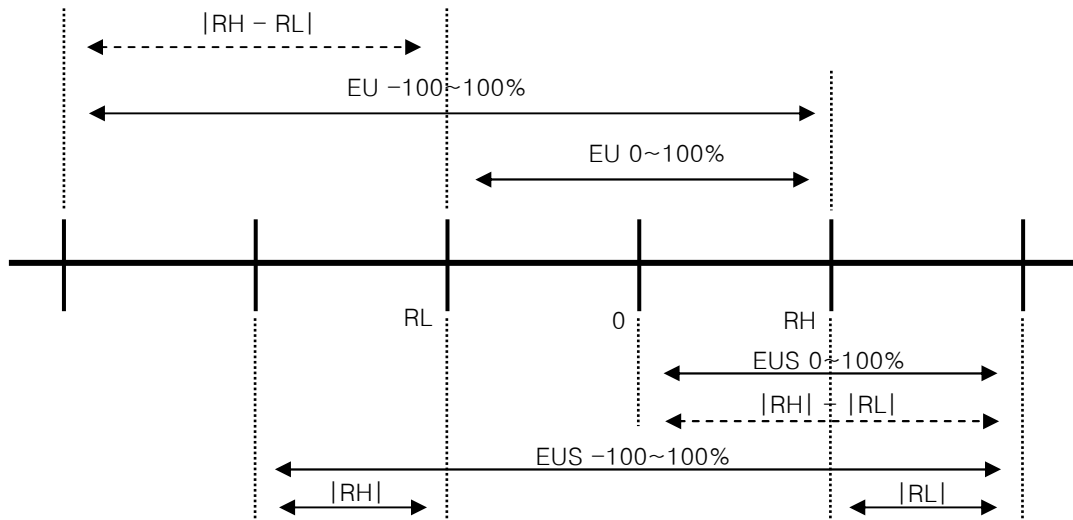

- ▶ The Range of EU(), EUS()

	RANGE	CENTER POINT
EU 0 ~ 100%	RL ~ RH	$ RH - RL / 2 + RL$
EU -100 ~ 100%	$-(RH - RL + RL) \sim RH$	RL
EUS 0 ~ 100%	$0 \sim RH - RL $	$ RH - RL / 2$
EUS -100 ~ 100%	$- RH - RL \sim RH - RL $	0

- ▶ INPUT = TC.K2

















- ▶ RANGE = -200.0°C(RL) ~ 1370.0°C(RH)

	RANGE	CENTER POINT
EU 0 ~ 100%	- 200.0 ~ 1370.0°C	585.0°C
EU -100 ~ 100%	- 1770.0 ~ 1370.0°C	- 200.0°C
EUS 0 ~ 100%	0 ~ 1570.0°C	785.0°C
EUS -100 ~ 100%	- 1570.0 ~ 1570.0°C	0.0°C



























- ☞ ABS denotes absolute value and does not change with input.

Alpha-numeric Displays of the product

Numbers in 7-Segment LED Display

0	1	2	3	4	5	6	7
							
8	9	.	-	/	Half -	Half 1	Half -1
							

Alphabets in 7-Segment LED Display

A, a	B, b	C, c	D, d	E, e	F, f	G, g	H, h
							
I, i	J, j	K, k	L, l	M, m	N, n	O, o	P, p
							
Q, q	R, r	S, s	T, t	U, u	V, v	W, w	X, x
							
Y, y	Z, z						
							



Note : Numeric 5 and alphabet S appear the same way

CONTENTS

Important Safety Guide	
Precautions on Environment and Installations	
Engineering Units – EU, EUS	
Alpha-numeric Displays of the product	
	PAGE
1. Introduction	14
1-1 Product outline	14
1-2 KEY Operation	17
1-2-1 Part names and functions	17
1-2-2 KEY Operation	18
1-2-3 Front panel and LEDs	20
1-3 Terminal layout and connection diagram	21
1-3-1 Terminal layout	21
1-3-2 Connection diagram	21
1-4 Parameter Map (deployment diagram)	22
1-4-1 Parameter Flow	22
1-5 Initial parameter setting sequence	24
2. Electrical wiring	25
2-1 Power cable specification	25
2-2 Terminal connector specification	25
2-3 Countermeasures against noise	25
2-4 Wiring	26
2-4-1 Ground and power source	26
2-4-2 Sensor input	26
2-4-3 Control out	27
2-4-4 Digital output and input	28
2-4-5 Auxiliary Relay	29
2-4-6 CT sensor for detecting Heater Break	30
2-4-7 Front communication port	30
3. Mounting of the product	31
3-1 Dimensions	31
3-2 Panel cut-out size	31
3-2-1 Close-packed mounting	31
3-2-2 General mounting	31

3-3 Mounting procedure	32
3-4 Disassembly of TERMINAL CASE ASSY and wiring	33
4. Functions	34
4-1 Sensor input (G.IN)	34
4-1-1 Input Type	35
4-1-2 Temperature unit	35
4-1-3 Input range	35
4-1-4 Decimal point	35
4-1-5 PV display range	36
4-1-6 Input filter	36
4-1-7 Display filter	37
4-1-8 Burn-out detection	37
4-1-9 Reference Junction Compensation	37
4-1-10 Entire-range correction	38
4-1-11 Piecewise correction	38
4-1-12 PV Limiter	39
4-2 Control output (G.OUT)	41
4-2-1 Output Kinds	41
4-2-2 Output control direction	42
4-2-3 Output period (Cycle Time)	42
4-2-4 Output limit	43
4-2-5 Output change rate	43
4-2-6 Output in an emergency	43
4-2-7 OUT LED display	43
4-3 Control Functions (G.CTL)	44
4-3-1 Out duration at Pattern End	44
4-3-2 User Screen	44
4-3-3 User defined key	44
4-3-4 Key Lock	44
4-3-5 External Contact Input (DI)	44
4-3-6 Output Status display	45
4-3-7 PV Display High, Low Limit	45
4-3-8 PASSWORD	45
4-3-9 Initialization of the controller	45
4-4 Communication (G.COM)	46
4-4-1 Protocol selection	46

4-4-2 Baud rate	46
4-4-3 Parity	46
4-4-4 Stop Bit	46
4-4-5 Data Length	46
4-4-6 Communication Address	47
4-4-7 Response Time	47
4-5 Auto Tuning (G.AT)	48
4-5-1 Auto tuning	49
4-5-2 GAIN setting	49
4-6 Alarm (G.ALM)	51
4-6-1 Alarm Types	54
4-6-2 Alarm points	54
4-6-3 High/Low Deviation Alarm	54
4-6-4 Dead Band	55
4-6-5 Delay Time	55
4-7 PID Group (G.PID)	56
4-7-1 ARW (Anti Reset Wind-up)	57
4-7-2 Control Mode	57
4-7-3 Fuzzy Function	57
4-7-4 PID Number	58
4-7-5 Proportional band	58
4-7-6 Integration time	59
4-7-7 Derivation time	59
4-7-8 Manual set value of Integration time	59
4-7-9 PID Zone setting	59
4-7-10 PID DEAD BAND	59
4-7-11 Deviation value used in deviation PID	59
4-8 Program Group (PROG)	61
4-8-1 Time Unit (TMU)	65
4-8-2 Start Code Set point (STC)	66
4-8-3 Waiting Zone (W.ZON)	66
4-8-4 Wait Time (W.TM)	66
4-8-5 Link Code (.LC)	66
4-8-6 Starting Set Point (.SSP)	66
4-8-7 Target Set Point of Segment	67
4-8-8 Segment Time	67

4-8-9 Time Signal	67
4-8-10 Number of Segment Repeat	67
4-8-11 Last segment number of repeating segment group	68
4-8-12 First segment number of repeating segment group	68
4-9 Inner Signal Group (G.IS)	69
4-9-1 Type to be referenced (.IST)	69
4-9-2 Out or In band (.ISB)	69
4-9-3 High/Low limits of band (.ISH, .ISL)	69
4-9-4 Delay Time (.ISD)	69
4-10 Retransmission Group (G.RET)	72
4-10-1 Type of retransmission (RET)	72
4-10-2 High and low limits (RETH, RETL)	73
4-11 Heater Break Alarm	74
4-11-1 Heater Current Display	74
4-11-2 Heater Current Alarm Point	74
4-11-3 Dead band	74
* Error Display and Correction	76
5. Communication (G.COM)	77
5-1 Outline	77
5-2 Wiring of communication	77
5-3 Communication parameters	78
5-4 Standard protocol	79
5-4-1 Communication Command	79
5-4-2 General Command	80
5-4-2-1 Read Command	80
5-4-2-2 Write Command	82
5-4-2-3 Monitoring Command	83
5-4-3 Information Command	85
5-4-4 Error Code	86
5-5 MODBUS protocol	87
5-5-1 Communication Function Code	87
5-5-1-1 Function code-03	87
5-5-1-2 Function code-06	88
5-5-1-3 Function code-08	89
5-5-1-4 Function code-16	90
5-5-2 Error Code	91

5-6 SYNC Communication	92
5-6-1 SYNC-Master	92
5-6-2 SYNC-Slave	92
5-7 D-Register Map	93
5-7-1 Process	93
5-7-2 Function	94
5-7-3 Set Point	94
5-7-4 Signal	95
5-7-5 Alarm	95
5-7-6 PID	96
5-7-7 IN/OUT	96
5-7-8 PT_Info	98
5-7-9 PT1/PT2	98
* D-Register 0000~0499	99
* D-Register 0500~0999	101
* D-Register 1000~1399	103
* BIT-MAP Information	105

1. INTRODUCTION

1-1. Product Outline

SP541 is a programmable controller with advanced design and functions. Short body (78 mm) is convenient to install at a small space. More informative displays such as 5-digit PV display, 8 status lamps, and more comprehensive display menus are equipped.

It can measure many types of analog signals including thermo couple, RTD, DC voltage (up to 10V) with high precision ($\pm 0.1\%F.S$). It is suitable for precise temperature control, because its advanced PID control algorithm and multiple output types, RELAY, SSR, 4-20 mA.

The Displays are composed of 3 screen categories, Operation, Menu, and Test. Menu has informative group titles and relevant parameters in each groups. The comprehensive parameter map enables users to understand the meaning easily and operate the controller safely. It is highly recommended that initial controller setting should be carried out as following sequence : " INPUT Group \rightarrow OUTPUT Group \rightarrow Other Group". Especially, the user should set the parameters in INPUT Group first of all, because they are the most influential to other group parameters.

■ Features

Item	Feature
LED display	PV/SP : 7-Segment 4½ digit x 2 Status : LED(RED/GREEN) x 8
Sampling time	250ms
Input Precision	$\pm 0.1\%$ of FS ± 1 digit
Control loop	1 loop
PID	4 sets (3 Zone PID / 1 Deviation PID)
Sensor Input	Universal input 1 port Types <ul style="list-style-type: none"> - Thermocouple (T/C) : K, J, E, T, R, B, S, L, N, U, W, PLA II, C - RTD : PtA, PtB, PtC, PtD, JPtA, JPtB - DC Volt : 0.4 ~ 2V DC, 1 ~ 5V DC, 0 ~ 10V DC, -10 ~ 20mV DC, 0 ~ 100mV DC (4 ~ 20mA DC: 250Ω;0.1% shunting to 1~5V)

Control Output	<p>Universal output(MAX 3 ports)</p> <p>Output Types</p> <ul style="list-style-type: none"> - SSR(0 ~ 12V DC) 500Ω Min - SCR(4 ~ 20mA DC) 500Ω Max - RELAY(250V AC 1A, 30V DC 1A) : EV1 - DC current & voltage : OUT1(Option) <p>(0 ~ 20mA DC, 0 ~ 5V DC, 1 ~ 5V DC, 0 ~ 10V DC, 0 ~ 100mV)</p>
Relay Contact (EVENT)	<p>2 Common 2 Points / 1 Common 3 Points (Option)</p> <p>Types : HEAT, ALM1, ALM2, ALM3, RUN, IS1, IS2, TS, P.END, UP, DOWN, SOAK</p> <p>Relay Specification</p> <ul style="list-style-type: none"> - Relay : Normal Open 30V DC 1A max, 250V AC 1A max
Retransmission	<p>4 ~ 20mA DC</p> <p>Types : PV, SP, MV, Loop power supply</p>
External Contact (DI)	<p>1 Common 2 Points</p> <p>Specification</p> <ul style="list-style-type: none"> - Mechanical contact : On-Off repeatability at 5 V Open voltage, 1mA Short circuit current - Open collector : ON state voltage 2V max, Leakage 100μA max
Heater Break	<p>Precision : ±3% of FS ±1 digit</p> <p>CT spec. : CTL-6-S-H or 800:1 CT</p>
Communication	<p>RS485 (rear terminal) / RS232 (front side : USB type port)</p> <p>Protocol : PC Link, MODBUS ASCII, MODBUS RTU, SYNC Master, SYNC Slave</p> <p>Baud rate : 4800, 9600, 19200, 38400 bps</p>
Power Source	<p>Rated Voltage : 100~240V AC, 50/60Hz</p> <p>Rated Power : Max 6VA</p>
Operation Environment	<p>Temperature : 10 ~ 50℃, Humidity : 20 ~ 90%RH</p>
Weight	<p>about 136 g</p>

■ Model and Suffix Code

Type	Suffix Code				Function
S*541 -					P : Programmable Controller T : Fixed SP Controller L : Limit Controller
Control Method	0 1				Normal Control Heat/Cool Control
Power Supply		0 1			100~240V AC(50/60Hz) 24V AC(50/60Hz) / 24V DC
Option1			/RS /SUB /DI /HBA		RS485/232 Dependent 3 Relay DI 2 Points HBA(50A)
Option2				/DCV1 /DCV2 /DCV3 /DCV4	0 ~ 20 mA DC(OUT1) 0 ~ 5 V DC(OUT1) 1 ~ 5 V DC(OUT1) 0 ~ 10 V DC(OUT1)

* When DCV1 Option selected, OUT2 is not available

■ Standard and Options

Function		Description
Control Method	Normal Control	Standard
Power Supply	100~240V AC	Standard
	24V AC/DC	Option
Option1	RS(RS485/232)	Option (selectable up to 3 ea) DI and HBA are exclusive
	SUB(3 Relay)	
	DI(DI2 point)	
	HBA(50A)	
Option2 (OUT1)	0~20mA, 0~5V, 1~5V, 0~10V	Option (only one of these)

1-2. KEY operation

1-2-1 Parts names and functions

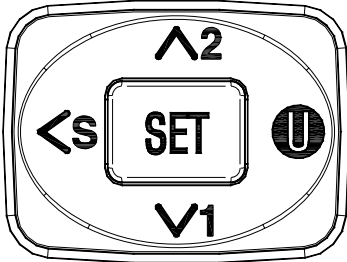
Name	Function
KEY	
"SET" (SET)	<ul style="list-style-type: none"> ▪ To select a parameter or enter the setting value ▪ To change the display screen in RUN screen ▪ "SET" KEY press 3 sec at Run screen → MENU screen ▪ "SET" KEY press 3 sec at Menu screen → Run screen
" ^ " (UP)	<ul style="list-style-type: none"> ▪ To change the parameter value ▪ To move from a group to the next group (UP direction) ▪ To run pattern No. 2 (pressing 3 seconds)
" v " (DOWN)	<ul style="list-style-type: none"> ▪ To change the parameter value ▪ To move from a group to the next group (DOWN direction) ▪ To run pattern No. 1 (pressing 3 seconds)
" < " (SHIFT)	<ul style="list-style-type: none"> ▪ To select a digit to modify when parameter value editing ▪ To stop a pattern run (pressing 3 seconds)
" U " (USER)	<ul style="list-style-type: none"> ▪ To operate user-defined key at PV display screen pressing 3 seconds ▪ At parameter editing menu screen <ul style="list-style-type: none"> Key click → To move to previous parameter Pressing 3 sec. → To move to top group menu ▪ AT(Default), STEP, HOLD (selection)

1-2-2 KEY operation

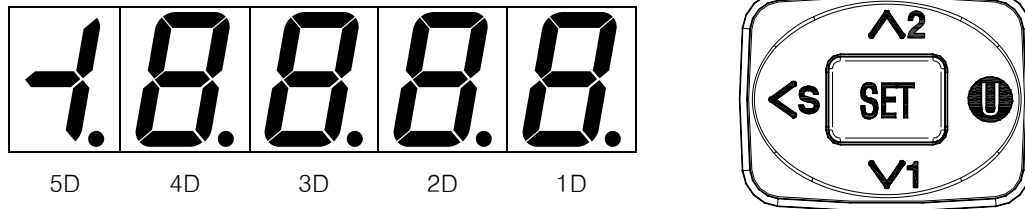

a) " ^2", " v1" KEY : digit display limit

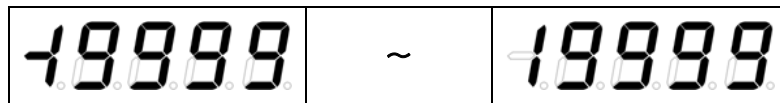

b) DIGIT carry operation when increasing or decreasing

- increasing

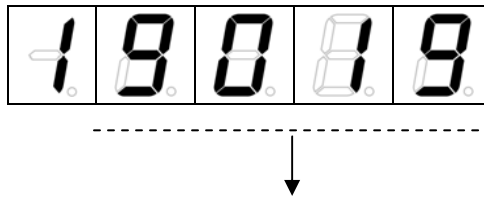

Pressing " ^ " KEY at digit "0" (except 5D,4D position), carry digit is added to upper next digit.

- decreasing

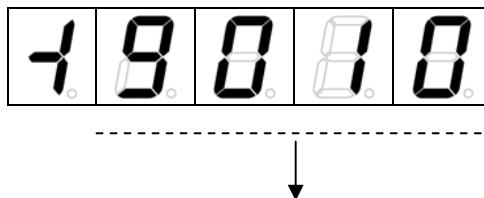

① Positive number digits

Pressing " v " KEY at "0" (except 5D position) the digit becomes "9" and the upper next digit decreases by one.

② Negative number digits

Pressing " v " KEY at "9" (except 5D position) the digit becomes "0" and the upper next digit increases by one without changing sign.

c) MIN, MAX handling

- When the value reaches upper or lower limit, MAX or MIN value will be displayed.

ex) W.TM = 0.00 ~ 99.59

If a user set a value higher than 99.60, the maximum value of W.TM, 99.59 will be set and displayed. If the user set -0.02, the minimum 0.00 will be set and displayed.

d) "<S" KEY

- The digit to be edited is BLINKING as a cursor.

e) SET KEY

① Run screen

- To move to other parameter or to enter the parameter value modified
- To move to parameter setup group by pressing SET key 3 seconds

② Parameter setup screen

- After editing a parameter value by the keys of " \wedge 2", " \vee 1", "<S", pressing SET KEY, the changed value will be registered and the next parameter will appear. The value should be within the range of the limits.
- Pressing SET KEY repeatedly without touching other key, the next parameter item will appear in turn.
- To move to Run screen by pressing SET key 3 seconds

f) \textcircled{u} KEY

① Run screen

- To execute user-defined function by pressing this key 3 seconds
(AUTO TUNING, STEP, HOLD etc.)

② Parameter setup screen

- ex) To visit around the parameters in reverse order by pressing the key repeatedly.

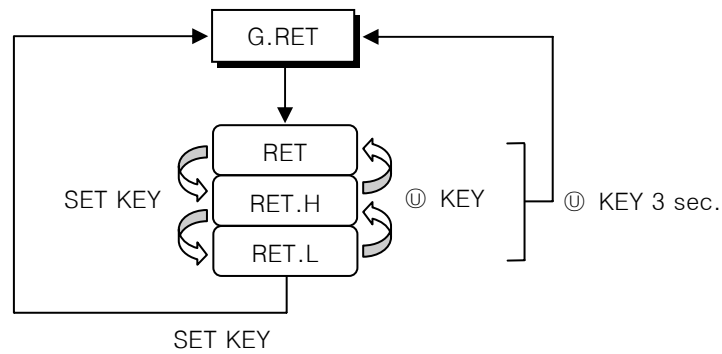

g) "- (MINUS)" position

In case MSD (the most significant digit) is in

- 1D, the position of (-) is 2D
- 2D, the position of (-) is 3D
- 3D, the position of (-) is 4D
- 4D, the position of (-) is 5D
- 5D, the position of (-) is 5D (only -1)

1-2-3 Front panel and LED lamps

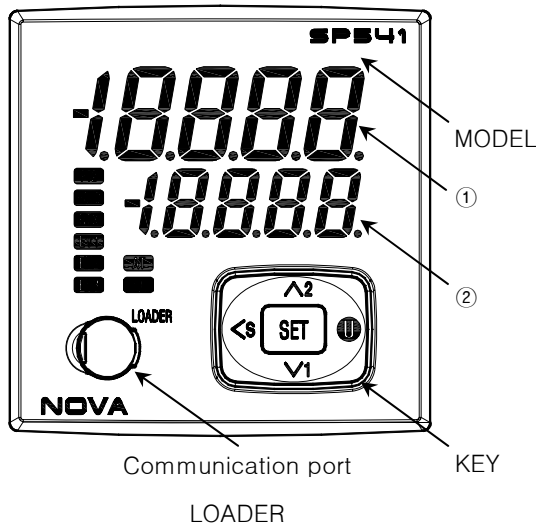

LED	Function
①	Displays Process Value (RED)
②	Displays Set Point (RED)
PT2	On while PATTERN2 runs (GREEN)
HOLD	On while HOLD state (GREEN)
RTX	Blink while communicating (YELLOW)
EV1	On while EVENT1 is active (RED)
EV2	On while EVENT2 is active (RED)
EV3	On while EVENT3 is active (RED)
AT	On while AUTO TUNING is progressing (GREEN)
OUT	On/Off with control output (GREEN)
LOADER	Communication port, LOADER

1-3. Terminal layout and diagram

1-3-1 Terminal Layout

No.	Description				
	Standard	Option		Standard	Option
1	OUT1+(SSR/SCR)	OUT1+(DCV)	11	POWER N	
2	OUT1,2-(SSR/SCR)	OUT1-(DCV)	12	POWER L	
3	OUT2+(SSR/SCR)	-	13	-	DI1
4	INPUT A		14	-	DI2
5	INPUT B+		15	-	COM
6	INPUT B-		16	-	RTX+
7	EVENT1(RELAY)	EVENT1(RELAY)	17	-	RTX-
8	EVENT1_COM1	EVENT2(RELAY)	18	-	SG
9	EVENT2(RELAY)	EVENT3(RELAY)			
10	EVENT2_COM2	EVENT_COM			

1-3-2 Diagram for wiring

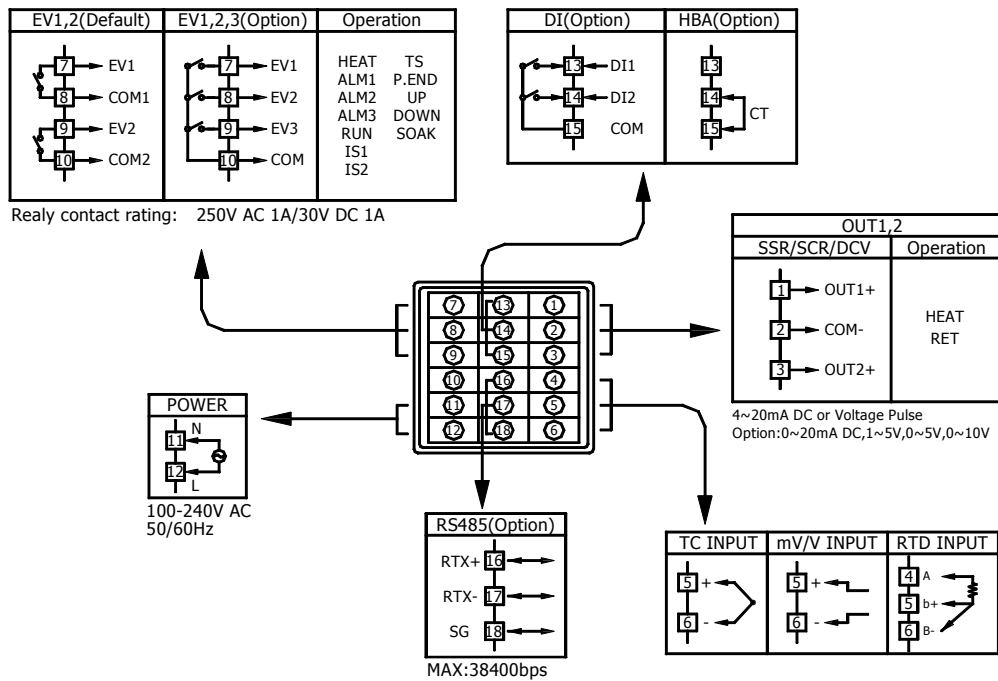

1-4. Parameter Map

1-4-1 Parameter Flow

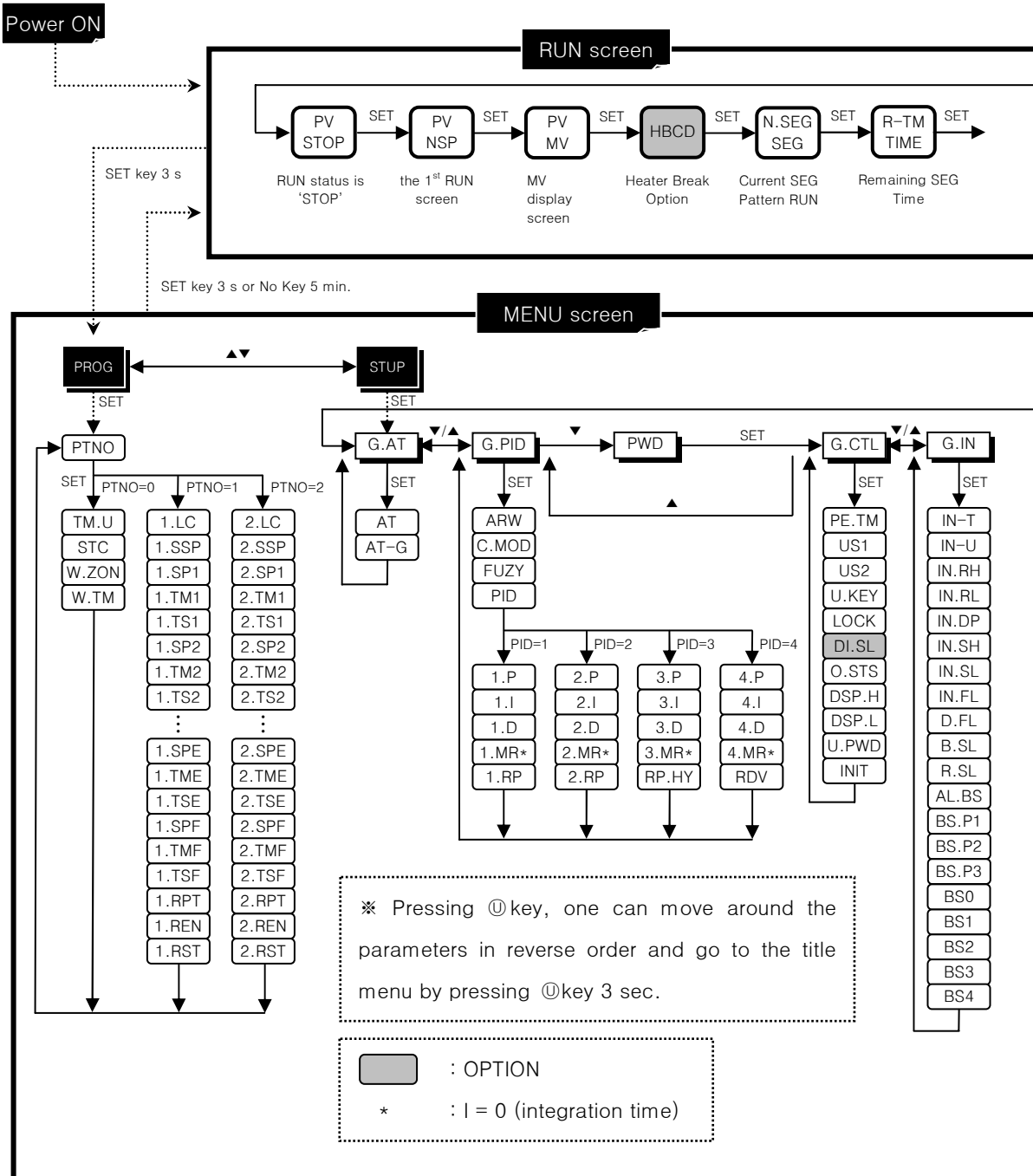

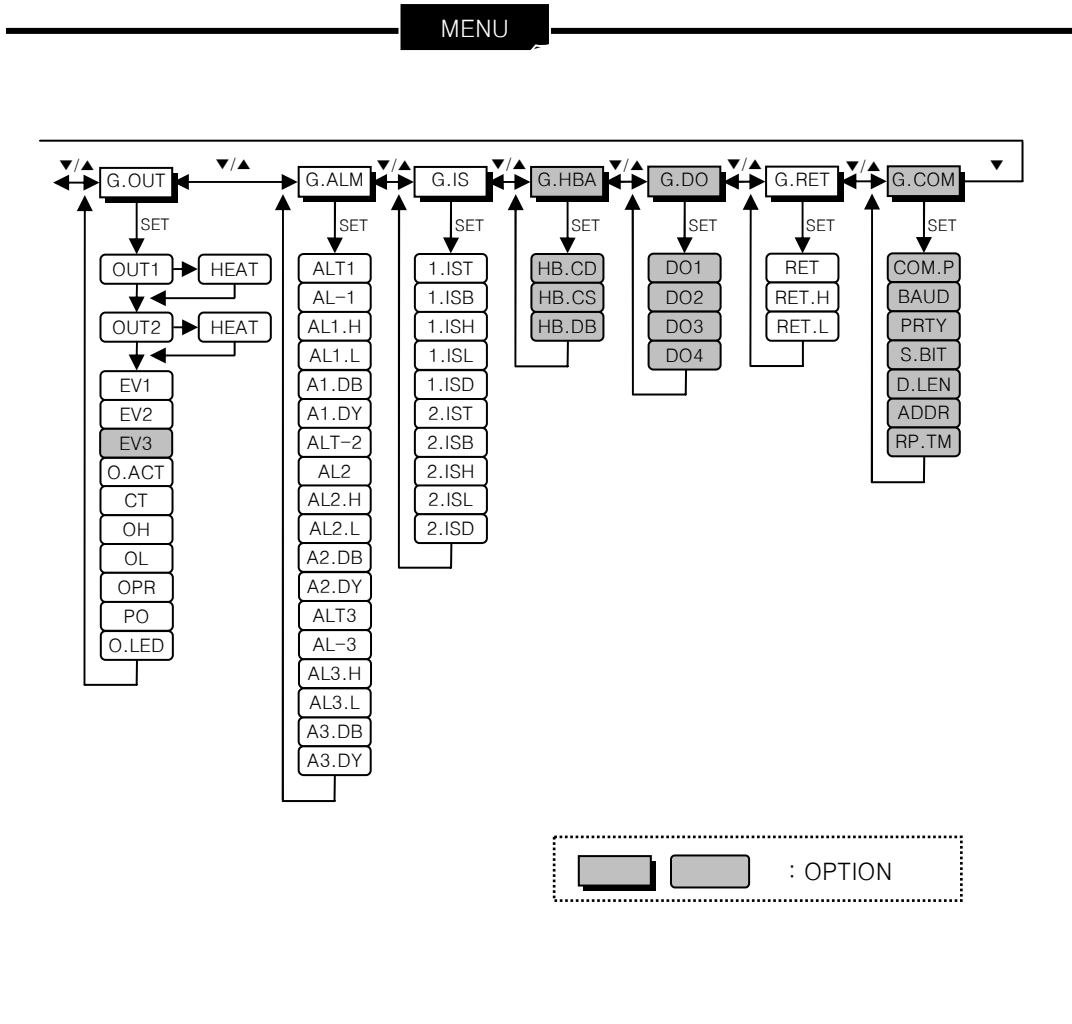
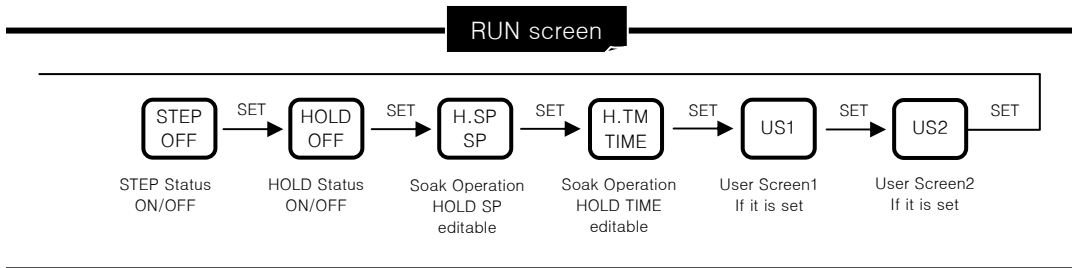

1-5. Initial parameter setting sequence

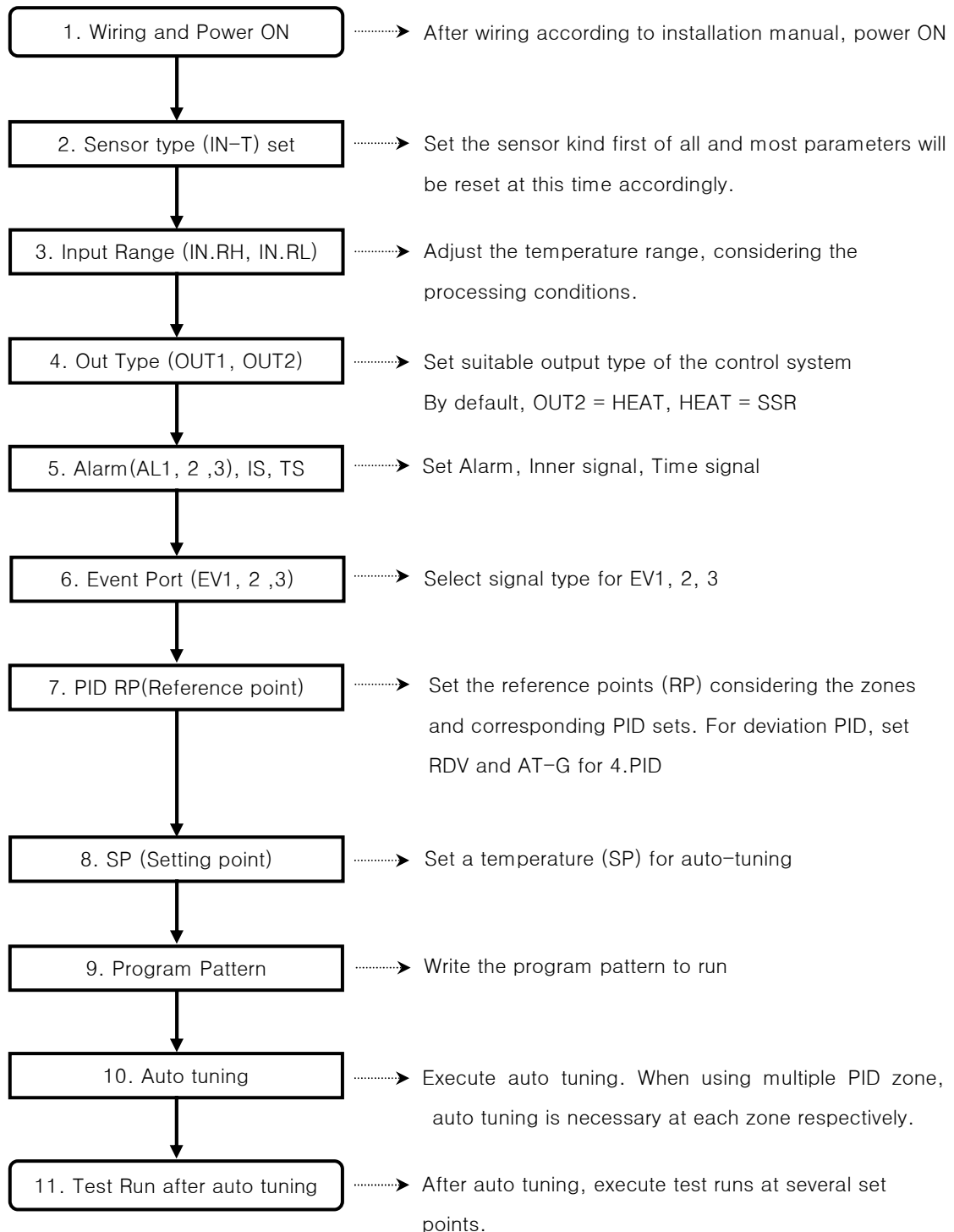

2. Electrical Wiring



Precaution

- Switch off the main power supply and make sure that no current flows in all the circuits before the wiring work.
- Do not touch the real terminal part while the power is on.
- Main circuit breaker must be kept in OFF state until all the wiring work is done.

2-1 Power cable specification

- ▶ Vinyl-insulated shielding cable KSC 3304 0.9 ~ 2.0 mm²

2-2 Terminal connector specification

A terminal with PVC insulating sleeve for M3.5 screw as shown in the following figure.

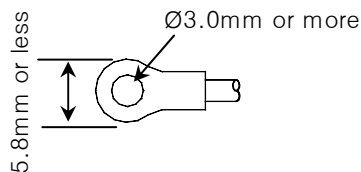

2-3 Countermeasures against noise

- Noise source
 - (1) Relay and Electrical contacts
 - (2) Solenoid coil, Solenoid Valve
 - (3) Power Line
 - (4) Inductive load
 - (5) Inverter
 - (6) Rectifier of a Motor
 - (7) Phase-angle controlled SCR
 - (8) Wireless communication devices
 - (9) Welding machines
 - (10) High-tension magneto-Ignition system

■ Countermeasures against noise

Notice following guide while wiring work.

- (1) The wires of input signal should be apart from power line and grounding line.
- (2) Use a shielded wire to guard against a noise from electrostatic induction. Multi-point grounding should be avoided and connect the shield wire to ground terminal if necessary.
- (3) It is effective to make the input wires as a twisted pair to prevent an electromagnetic noise.
- (4) When using an auxiliary relay, refer to section 2-1-4-5.

2-4 Wiring

2-4-1 Ground and power source

- ▶ Use a thick grounding wire ($> 2\text{mm}^2$) and make short wiring ($< 20\text{m}$) so that the grounding resistance is less than 100 Ohm (class 3 or better).
- ▶ Make 1-point grounding from a ground terminal and avoid a wiring cross over the grounding wire.
- ▶ For power source wiring, use a vinyl-insulated wire (KSC 3304 or better).

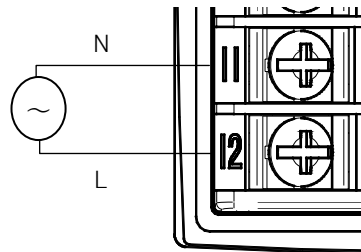

2-4-2 Sensor input

- ▶ Be careful of the polarity of the signal. The wrong connection may cause a trouble.
- ▶ Use a shielded wire for analog input and the shield should be 1-point grounded.
- ▶ The wires of input signal should be apart from power line and grounding line.
- ▶ Use a wire of low resistance. The resistance difference between the wires is unfavorable especially for a resistive sensor (ex. RTD).

(1) RTD INPUT

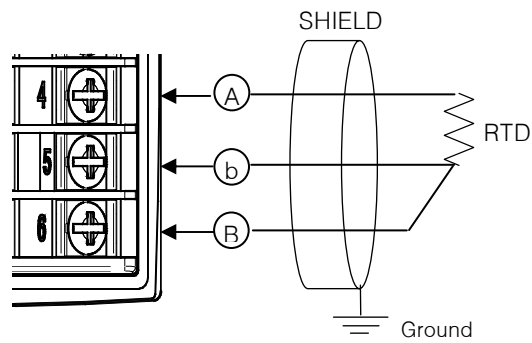

(2) DC VOLTAGE INPUT

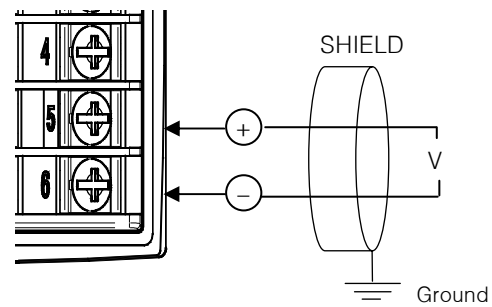

(3) DC CURRENT INPUT

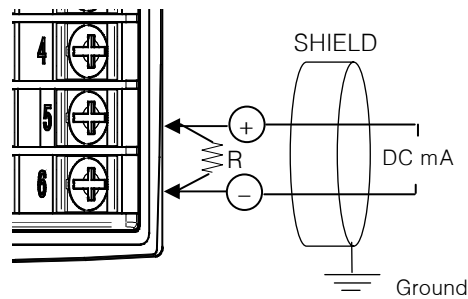

2-4-3 Control out

- ▶ Be careful of the polarity. The wrong wiring may cause a trouble in the product.
- ▶ Use a shielded wire for analog input and the shield should be 1-point grounded.

(1) Voltage pulse (SSR)/ Current Output (SCR)

■ OUT1

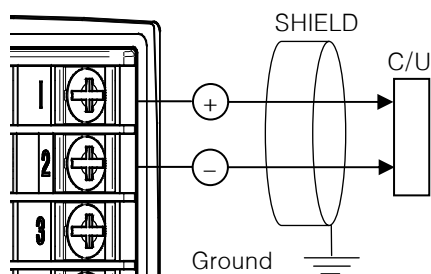

SSR : 12V DC min, 500 Ω min
 SCR : 4~20mA DC, 500 Ω max
 DCV : 0~20mA DC, 1~5V DC
 0~5V DC, 0~10V DC

■ OUT2

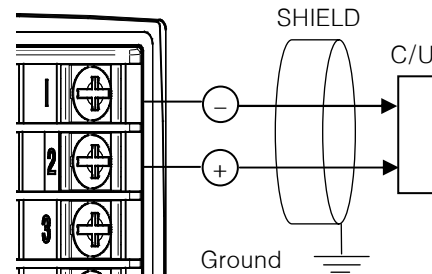

SSR : 12V DC min, 500 Ω min
 SCR : 4~20mA DC, 500 Ω max

(2) Retransmission (RET)

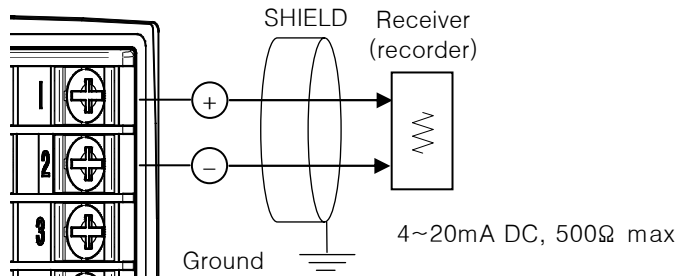

2-4-4 Digital output and input

- ▶ RELAY : Normal Open 30VDC 1A max, 250VAC 1A max.

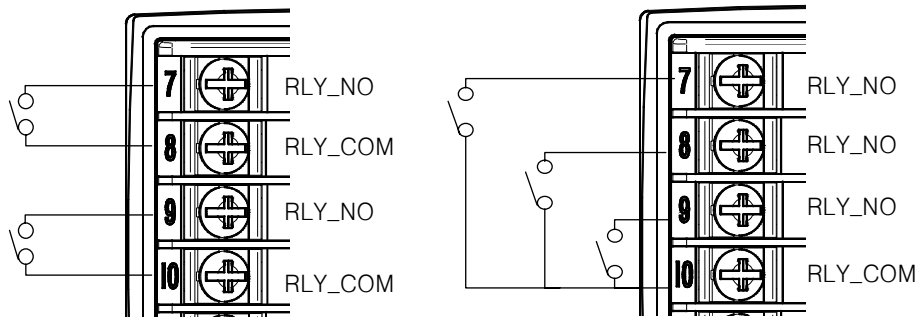

- ▶ Use a mechanical contactor (non-voltage type) as relay for the digital input (DI).
- ▶ The relay for DI must have sufficient on-off repeatability at 5V open voltage and 1 mA short circuit current.
- ▶ The open collector for DI should have low ON state voltage (<2V) and low leakage current less than 100μA at OFF state.

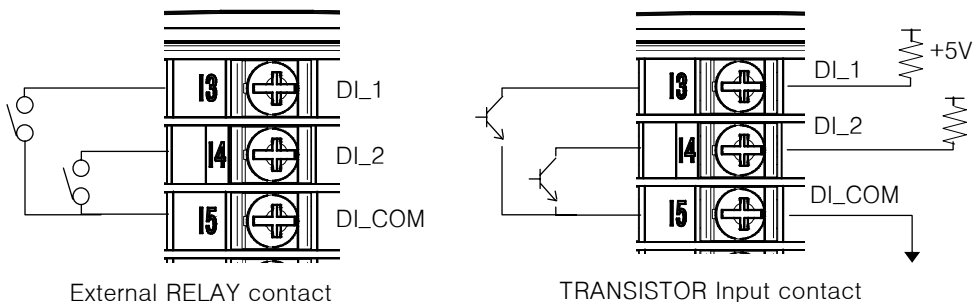

2-4-5 Auxiliary Relay

**Precaution****CAUTION**

- If the wattage of the load is greater than the rating of output relay, an auxiliary relay should be used to on/off power on the load.
- ▶ When an inductive switch as a relay and a solenoid valve is used, it may be a noise source. A protective circuit should be installed to suppress a surge. CR filter (AC) or Diode (DC) should be connected with the mechanical contact in parallel.
- ▶ CR FILTER recommended
 - Sung Ho Electronics (Korea) : BSE104R120 25V (0.1 μ +120 Ω)
 - HANA PARTS CO. : HN2EAC
 - Matsuo Electric Co., LTD (Japan) : CR UNIT 953, 955 etc
 - Shizuki Electric Co., Inc.(Japan) : SKV, SKVB etc
 - Rubycon Co. (Japan) : CR-CFS, CR-U etc

① DC RELAY



※ RELAY

The rating of RELAY COIL should be less than that of OUT relay of the controller

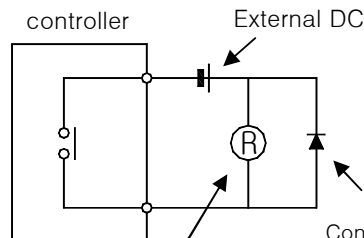
**CAUTION**

Connect the DIODE to the RELAY COIL terminal directly.

② AC RELAY



※ RELAY

The rating of RELAY COIL should be less than that of OUT relay of the controller

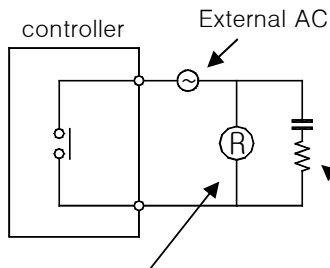
**CAUTION**

Connect the CR FILTER to the RELAY COIL terminal directly.

2-4-6 CT sensor for detecting Heater Break

- This function is available only when OUT type is SSR or RELAY.
- The winding ratio of CT Sensor should be 800:1.
- To detect the heater current, the output pulse width should be longer than 200 ms.

If the cycle time of SSR OUT is 2 sec, MV should be greater than 10% to detect the heater current.

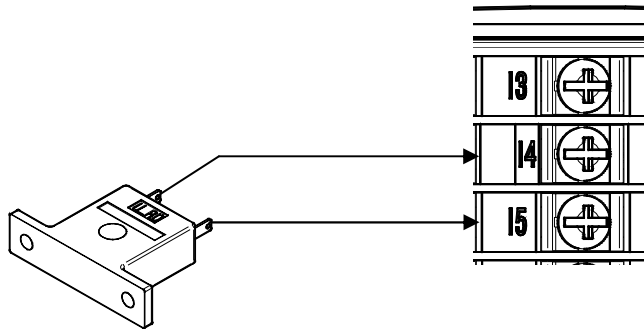

2-4-7 Front communication port

- It is necessary to purchase LOADER(Optional) cable to use the front communication.
- Rear communication (RS485) will be disabled automatically when using front LOADER.
- Parameter setting and monitoring is available with the bundle software program.

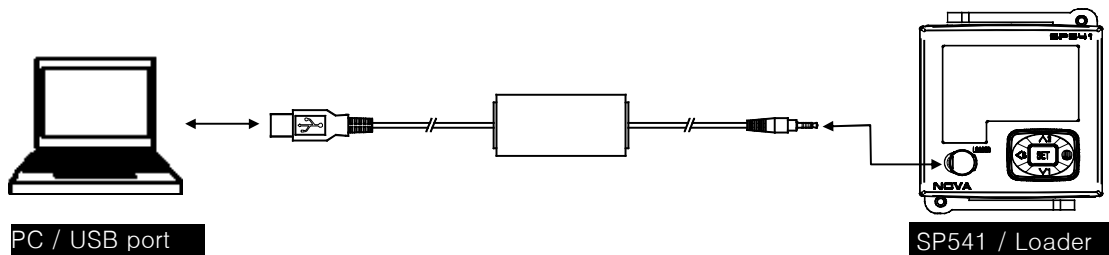

3. Mounting



Precautions

- To prevent an accident or trouble, the environmental operation conditions should be observed the specifications specified in the manual (temperature, humidity, voltage, vibration, shock, mounting, atmosphere)
- Do not block any vent hole on the controller to prevent a fire or a failure.

3-1. Dimensions

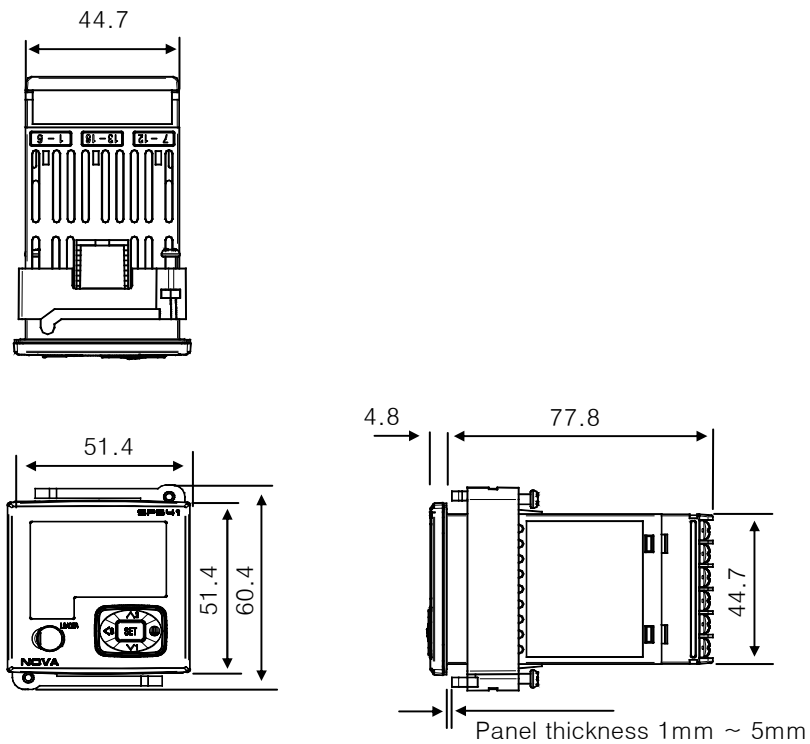

3-2. Panel cut-out size

3-2-1 Close-packed mounting

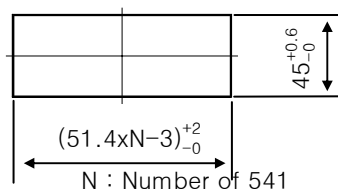

3-2-2 General mounting

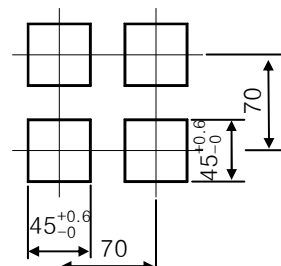

- ▶ When close mounting more than 3 ea., the ambient temperature should be kept below 40°C.
- ▶ The gap in vertical direction should be greater than 50mm.

3-3. Mounting procedure

- ▶ Mounting slope angle is allowed within 10 degree from horizontal position in both up and down directions.
 - ▶ Panel should be a rigid metal plate with the thickness greater than 2mm.
- ① The controller should be inserted from the front side.

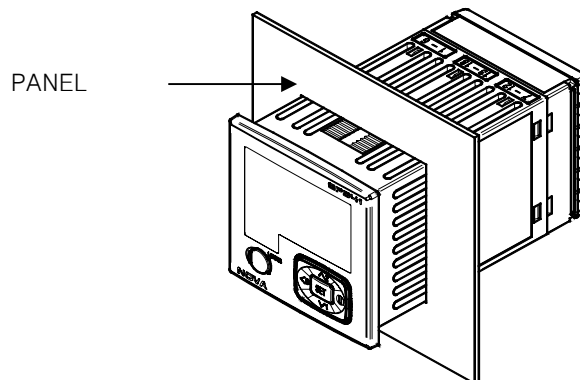

- ② Put the clamping latch on the controller from the rear side.
- ③ Push forward the clamping latch to be fixed around the controller.

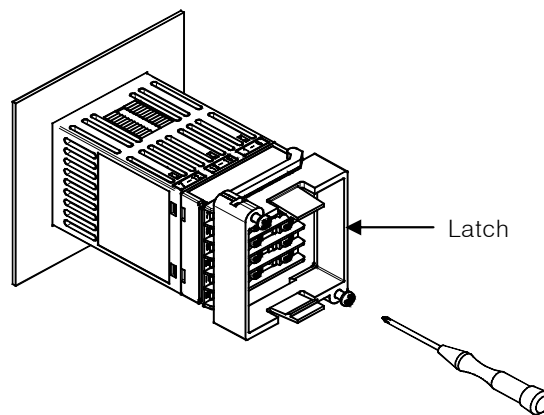

- ④ Fasten the screw bolts in the top and bottom.

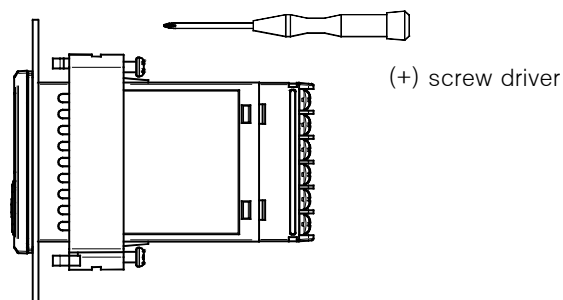

3-4. Disassembly of TERMINAL CASE ASSY

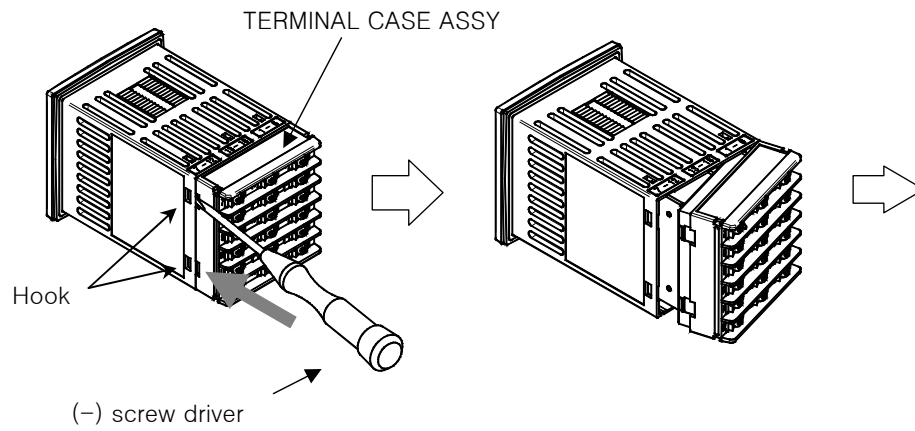

- ▶ Wedge off the two hooks with a (-) screw driver and open up the terminal case assy.

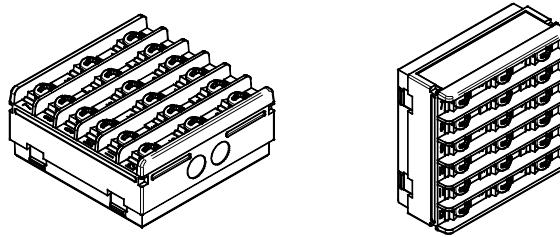

- ▶ The wiring work can be done with TERMINAL CASE ASSY separated.

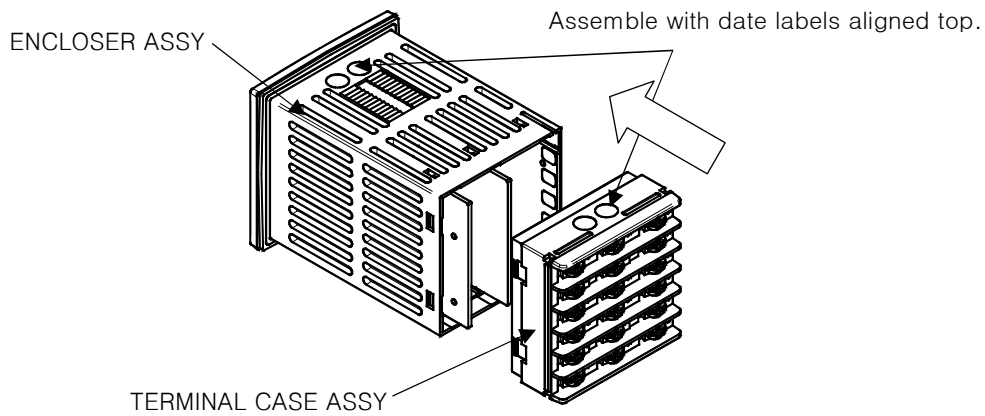

- ▶ After the wiring work, TERMINAL CASE ASSY is fitted to ENCLOSER ASSY aligning the date marks in the same direction.

4. Functions

4-1. Sensor input (G.IN)

Input Type (IN-T) : Thermocouple (TC), Resistive thermal detector (RTD), DC volt (DCV)

In case of TC or RTD, the sensor type and temperature range should be selected.

In case of DCV, the input types are classified with the range of input voltage.

Table 1. Input types

GROUP	DISPLAY	INPUT TYPE	RANGE(°C)	RANGE(°F)
TC	TC.K1	K1	-200 ~ 1370	-300 ~ 2500
	TC.K2	K2	-200.0 ~ 1370.0	-300.0 ~ 1900.0
	TC.J	J	-200.0 ~ 1200.0	-300.0 ~ 1900.0
	TC.E	E	-200.0 ~ 1000.0	-300.0 ~ 1800.0
	TC.T	T	-200.0 ~ 400.0	-300.0 ~ 750.0
	TC.R	R	0.0 ~ 1700.0	32 ~ 3100
	TC.B	B	0.0 ~ 1800.0	32 ~ 3300
	TC.S	S	0.0 ~ 1700.0	32 ~ 3100
	TC.L	L	-200.0 ~ 900.0	-300 ~ 1600
	TC.N	N	-200.0 ~ 1300.0	-300 ~ 2400
	TC.U	U	-200.0 ~ 400.0	-300.0 ~ 750.0
	TC.W	W	0 ~ 2300	32 ~ 4200
	TC.PL	Platine II	0.0 ~ 1390.0	32 ~ 2500
	TC.C	C	0 ~ 2320	32 ~ 4200
RTD	PTA	PTA	-200.0 ~ 850.0	-300.0 ~ 1560.0
	PTB	PTB	-200.0 ~ 500.0	-300.0 ~ 1000.0
	PTC	PTC	-50.00 ~ 150.00	-148.0 ~ 300.0
	PTD	PTD	-200 ~ 850	-300 ~ 1560
	JPTA	JPTA	-200.0 ~ 500.0	-300.0 ~ 1000.0
	JPTB	JPTB	-50.00 ~ 150.00	-148.0 ~ 300.0
DCV	2V	0.4 ~ 2.0V	0.400 ~ 2.000 V	
	5V	1 ~ 5V	1 ~ 5 V	
	10V	0 ~ 10V	0 ~ 10 V	
	20MV	-10 ~ 20mV	-10 ~ 20 mV	
	100MV	0 ~ 100mV	0 ~ 100 mV	

▪ Display range : -5% ~ +105% of above range

4-1-1 Input type

- Select the input type to use, considering sensor type and input range.
- Refer to Table 1 as a guide of sensor type and input range.

Symbol	Parameter	Setting range	Display	Unit	Default
IN-T	Input Sensor Type	Table1	Always	ABS	TC.K1

4-1-2 Temperature Unit (UNIT)

- Choose a temperature unit between “°C” and “°F”.
- Changing IN-U, the temperature range will be converted automatically.
- IN-U parameter appears only when IN-T is one of TC or RTD group.

Symbol	Parameter	Setting range	Display	Unit	Default
IN-U	Input Unit	°C, °F	IN-T = TC IN-T = RTD	ABS	°C

4-1-3 Input range

- Setting the high and low limits of the sensor input range
 - TC, RTD Input

When a RANGE CODE is selected, the range is set as Table 1. The range can be modified with IN.RH and IN.RL parameters. Decimal point position cannot be change by these parameters.

- DCV, mV Input

The input range can be determined by selecting a RANGE CODE and adjusted by modifying the parameters, IN.RH, IN.RL.

Symbol	Parameter	Setting range	Display	Unit	Default
IN.RH	Input Range High	Table 1 (IN.RH > IN.RL)	Always	EU	EU(100.0%)
IN.RL	Input Range Low				EU(0.0%)



Setting Example

- When the range code TC.K1 (-200~1370°C) is selected and setting IN.RL = -100 and IN.RH = 500, the input is limited in the range of -100~500°C.

4-1-4 Decimal point

- Determine decimal point place.
- When IN-T is one of TC, RTD group, IN.DP will skip.
- Decimal point place can be adjusted with IN.DP parameter when IN-T is one of DCV, mV.

Symbol	Parameter	Setting Range	Display	Unit	Default
IN.DP	Input Dot Position	0 ~ 4	IN-T = DCV	ABS	1



Precaution on changing decimal point

- Changing IN.DP, the decimal point of other parameters as well as PV will be changed.
The affected parameters are SP, Alarm, Event, Deviation related parameters.

4-1-5 PV display range

- Set the high and low limits of the scaled data of the input.
- TC, RTD : IN.SH, IN.SL will not appear.
- DCV, mV : The input signal is scaled with IN.SH and IN.SL value.

(100% input is scaled to IN.SH and 0% input is scaled to IN.SL with linear transformation)

Symbol	Parameter	Setting range	Display	Unit	Default
IN.SH	Input Scale High	-10000 ~ 19999	IN-T = DCV	ABS	100.0
IN.SL	Input Scale Low	(IN.SH > IN.SL)			0.0



Setting Example

- Input type is DCV and the range is 1~5V and scaled display need to be 0~100
IN-T : 5V
IN.SH : 100 (5V input is scaled to "100" display)
IN.SL : 0 (1V input is scaled to "0" display)

4-1-6 Input filter (IN.FL)

- When the noise level of the input signal is high, input filter reduces the effect of the noise.
- When PV fluctuation is significant, control is unstable, or PV ripples due to some vibration, the change rate of PV decreases with increasing the filter value.

$$PV = \text{Sensor Input} \times (1/1 + \text{IN.FL})@@$$

IN.FL : OFF, 1 ~ 120 sec

Symbol	Parameter	Setting Range	Display	Unit	Default
IN.FL	Input Sensor Filter	OFF, 1 ~ 120	Always	ABS	OFF

4-1-7 Display filter (D.FL)

- Reduce the fluctuation of PV display in FND.
- The control is not affected by D.FL value.

Symbol	Parameter	Setting Range	Display	Unit	Default
D.FL	Display Filter	OFF, 1 ~ 120	Always	ABS	OFF

4-1-8 Burn-out Detection (B.SL)

- When Sensor signal input is interrupted because of sensor burn-out or line break-off, PV will be set a certain value so that the operations, alarm action, PV retransmission, control output should be set with the PV.
- B.SL is used when the input type is in TC, RTD group.

B.SL (Burn-Out selection)		Up (Up Scale)	Down (Down Scale)	OFF (Off)
TC/RTD (invalid for DCV)	Detection	O	O	X
	PV set	105%	-5%	Indefinite
Remark			May be +105% temporarily for RTD	

- Detection case (B.SL = UP, DOWN) : retransmission and alarm action is affected.
MV should be Preset Output value.
- Non-Detection case (B.SL = OFF) : PV will be Indefinite
Preset Output will not work.

Symbol	Parameter	Setting range	Display	Unit	Default
B.SL	Burnout Select	OFF, UP, DOWN	Always	ABS	UP

4-1-9 Reference Junction Compensation (R.SL)

- Compensation of reference junction temperature for TC input group is automatically done.
- In most cases, R.SL should be "ON" because the TC voltage decreases by the emf of terminal temperature. If R.SL = OFF, the deviation in PV by terminal temperature will appear.
- In RJC ERROR situation, error message and PV is displayed in PV FND alternately and the control will continue with RJC = 0°C.

(Refer to page77, “Error display and correction”)

Symbol	Parameter	Setting range	Display	Unit	Default
R.SL	RJC Select	OFF, ON	IN-T = TC	ABS	ON

4-1-10 Entire-range correction (AL.BS)

- Adjust offset of PV display in entire range.

PV = Input + Bias in the whole range(AL.BS)

Symbol	Parameter	Setting range	Display	Unit	Default
AL.BS	All Bias Value	EUS(-100.0 ~ 100.0%)	Always	EUS	EUS(0.0%)

4-1-11 Piecewise correction

- Adjust 5 offsets of PV display by piecewise correction method.

Symbol	Parameter	Setting range	Display	Unit	Default
BS.P1	Reference Bias Point 1	EU(0.0 ~ 100.0%) IN.RL ≤ BS.P1 ≤ BS.P2 ≤ BS.P3 ≤ IN.RH	Always	EU	EU(100.0%)
BS.P2	Reference Bias Point 2				
BS.P3	Reference Bias Point 3				
BS0	Bias Value for IN.RL Point	EUS(-100.0 ~ 100.0%)	Always	EUS	EUS(0.0%)
BS1	Bias Value for BS.P1 Point				
BS2	Bias Value for BS.P2 Point				
BS3	Bias Value for BS.P3 Point				
BS4	Bias Value for IN.RH Point				



Piecewise input correction

- Getting corrected temperature at a temperature by piecewise correction
- R.PV = the input temperature, B.PV = temperature after correction,
IN.RL = low limit, IN.RH = high limit

$$\bullet \text{ IN.RL} \sim \text{BS.P1} : \text{B.PV} = \text{R.PV} + (\text{R.PV} - \text{IN.RL}) \times \frac{(\text{BS1} - \text{BS0})}{(\text{BS.P1} - \text{IN.RL})} + \text{BS0}$$

$$\bullet \text{BS.P1} \sim \text{BS.P2} : \text{B.PV} = \text{R.PV} + (\text{R.PV} - \text{BS.P1}) \times \frac{(\text{BS2} - \text{BS1})}{(\text{BS.P2} - \text{BS.P1})} + \text{BS1}$$

- BS.P2 ~ BS.P3 : $B.PV = R.PV + (R.PV - BS.P2) \times \frac{(BS3 - BS2)}{(BS.P3 - BS.P2)} + BS2$
- BS.P3 ~ IN.RH : $B.PV = R.PV + (R.PV - BS.P3) \times \frac{(BS4 - BS3)}{(IN.RH - BS.P3)} + BS3$

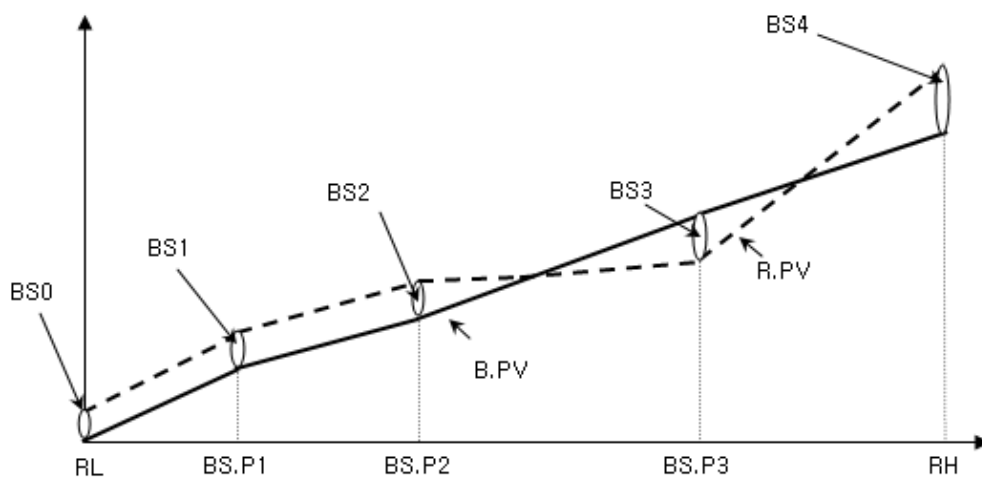

4-1-12 PV LIMITER

- If PV is less than EU(-5%) or greater than EU(105%), PV will be -OVR or OVR.
- For internal operation, PV will be set -5% when PV < -5% and PV will be set 105% when PV > 105%.

$PV > EU(105\%)$:	$PV = 105\%$, PV display = OVR
$EU(-5\%) \leq PV \leq EU(105\%)$:	$PV = PV$
$PV < EU(-5\%)$:	$PV = -5\%$, PV display = -OVR



Precaution

- If IN-T is changed, The parameters such as RH, RL, SH, SL will be initialized.
- The parameters of EU and EUS unit will be scaled with the sensor input range, therefore The parameters in G.IN should be set above all.



Setting Example

- Pt100Ω sensor is used in the range of $-50.0\sim 500.0^{\circ}\text{C}$ and display 1 decimal place.
- IN-T = PTA ⇨ PTA ($-200.0\sim 850.0^{\circ}\text{C}$)
- IN-U = °C ⇨ Display unit is °C.
- IN.RH = 500.0
- IN.RL = -50.0
- B.SL = UP ⇨ When sensor BURN OUT occurs, PV will be regarded as 500°C (UP scale).
- R.SL = ON ⇨ TC RJC (reference junction compensation) function will be activated.

4-2. Control Output (G.OUT)

- The kinds of output is determined by the parameters in G.OUT, OUT1, OUT2, EV1, EV2, EV3.
- As the type of output, SSR and SCR are available for OUT1, OUT2 and RELAY for EV1, EV2, EV3. (DCV can be provided for OUT1 as an option)

Table 2. Output kinds

OUTPUT	SSR/SCR/DCV	SSR/SCR	RELAY		
	OUT1	OUT2	EV1	EV2	EV3
CONTROL OUTPUT(HEAT)	◆	◆	◆		
ALARM SIGNAL1,2,3			◆	◆	◆
RUN SIGNAL			◆	◆	◆
UP SIGNAL			◆	◆	◆
DOWN SIGNAL			◆	◆	◆
SOAK SIGNAL			◆	◆	◆
INNER SIGNAL1,2			◆	◆	◆
TIME SIGNAL(TS)			◆	◆	◆
PATTERN END SIGNAL(P.END)			◆	◆	◆
RETRANSMISSION OUTPUT	◆	◆			

4-2-1 Output Kinds

Symbol	Parameter	Setting range	Display	Unit	default
OUT1	Analog Output 1	HEAT, RET	Always	ABS	HEAT
OUT2	Analog Output 2				RET
HEAT	Heat Output Type	SSR, SCR	OUT1, OUT2 = HEAT		SSR
EV1	Event Output 1	HEAT, ALM1, ALM2, ALM3, RUN, IS1, IS2, TS, P.END, UP, DOWN, SOAK	Always		ALM1
EV2	Event Output 2	ALM1, ALM2, ALM3, RUN	Option		ALM2
EV3	Event Output 3	IS1, IS2			ALM3



Forward and Reverse Control Action

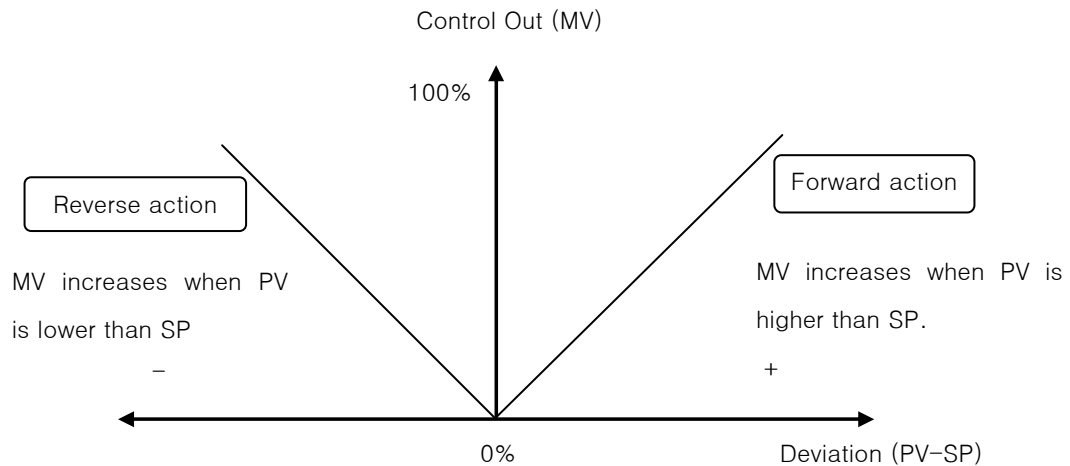

4-2-2 Output control direction (O.ACT)

- The direction of the control action : Reverse action (REV), Forward action (FWD).
- When O.ACT = REV, and $PV < SP$, output will be ON for RELAY or will increase for SSR, SCR type. When O.ACT = FWD, the direction of control action is quite the opposite.

Symbol	Parameter	Setting range	Display	Unit	Default
O.ACT	Output Direction	REV, FWD	Always	ABS	REV

4-2-3 Output period (Cycle Time)

- For Relay or SSR type, cycle time is single ON + OFF time and MV is the ON-time ratio with respect to the cycle time. As cycle time increases, the frequency of On/Off action decreases. Generally, Cycle Time is 30 sec for a relay output, and 2 sec for a SSR considering life time.

Symbol	Parameter	Setting range	Display	Unit	Default
CT	Heat Cycle Time	1 ~ 300 sec	Always	ABS	2 sec



Cycle Time

- Cycle time is valid only when output type is SSR (Solid State Relay) or RELAY.
- Cycle time is 1 period of ON + OFF time.
- In case the cycle time is 10 sec. (CT = 10)

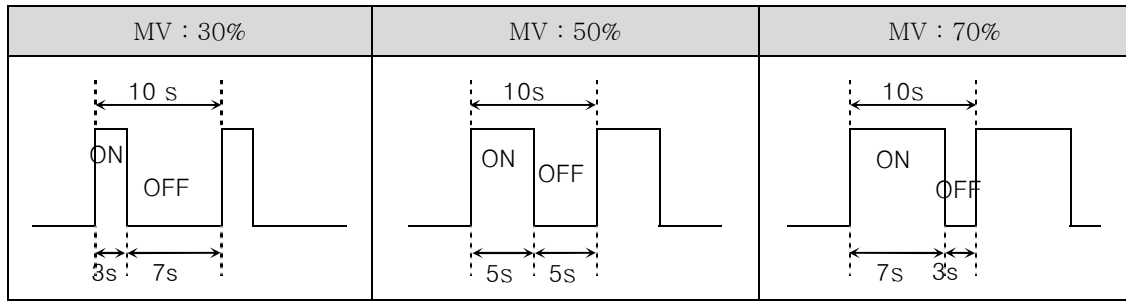

4-2-4 Output limit

- Set the limit of the control output (MV)
- OH is the high limit and OL is the low limit of MV. ($-5.0\% \leq OL \leq MVOUT \leq OH \leq 105.0\%$)

Symbol	Parameter	Setting range	Display	Unit	Default
OH	Output High Limit	(OL + 1Digit) ~ 105.0%	ON.OF = OFF	%	100%
OL	Output Low Limit	-5.0% ~ (OH - 1Digit)			0.0%

4-2-5 Output change rate

- Set output change rate in the unit of % /sec.

Symbol	Parameter	Setting range	Display	Unit	Default
OPR	Output Process Rate	OFF, 0.1 ~ 100.0%/sec	Always	ABS	OFF

4-2-6 Output in an emergency

- PRESET OUT (PO) is MV at an emergency situation.
- In case of STOP, A/D ERROR, BURN OUT, the Preset Out value will be set to MV instead of MV calculated by PID algorithm. This function is useful in case warming state should be kept.

Symbol	Parameter	Setting range	Display	Unit	Default
PO	Heat Preset Output	-5.0 ~ 105.0%	Always	%	0.0%

4-2-7 OUT LED Display

- MV OUT LAMP display mode

SSR : On/Off of MV Out Lamp is synchronized with that of SSR or RELAY output.

SCR : MV Lamp blinks regardless of CT as SCR mode.

Symbol	Parameter	Setting range	Display	Unit	Default
O.LED	Output LED	SSR, SCR	Always	ABS	SSR

4-3. Control Functions (G.CTL)

4-3-1 Out duration at Pattern End

- PEND signal is generated when a pattern run is ended, and maintained for the time in PE-TM.

Symbol	Parameter	Setting range	Display	Unit	Default
PE-TM	Pattern End Time	OFF, 1 ~ 9999 sec	Always	sec	15 sec

4-3-2 User screen

- The parameter used frequently or to be checked can be displayed in RUN Screen.

Symbol	Parameter	Setting range	Display	Unit	Default
US1	User Screen 1	OFF, D-Register No.(0001 ~ 1299)	Always	ABS	OFF
US2	User Screen 2				

4-3-3 User defined key

- Pressing Ⓞ key for 3 seconds, the function selected in U.KEY will be executed as a user defined function.

Symbol	Parameter	Setting range	Display	Unit	Default
U.KEY	User Define Key	OFF, AT, STEP, HOLD	Always	ABS	AT

4-3-4 Key lock

- When LOCK = ON, a user cannot edit any parameter value. This function can prevent an accidental trouble due to the wrong parameter setting by a user.

Symbol	Parameter	Setting range	Display	Unit	Default
LOCK	Key Lock	OFF, ON	Always	ABS	OFF

4-3-5 External Contact Input (DI)

- Select a Set of DI functions which is predefined for remote controls.
- RUN / STOP, HOLD, STEP functions can be executed by DI (external contact).

Table 3. DI Operation ('ON' is activated when the contact time is longer than 1 sec)

DI.SL	DI1	DI2	ACTION
OFF	-	-	NOT USE
1	OFF	-	HOLD OFF
	ON	-	HOLD ON
	-	OFF	STEP OFF
	-	ON	STEP ON

2	OFF	-	RESET
	ON	-	PROG RUN
	-	OFF	PROG1
	-	ON	PROG2

※ When DI.SL = 2 and DI1 = ON, PROG1 will RUN with DI2= OFF, PROG2 will RUN with DI2=ON.

Symbol	Parameter	Setting range	Display	Unit	Default
DI.SL	DI Select	OFF, 1, 2	DI Option	ABS	OFF

4-3-6 Output Status display

- When O.STS = ON, The status of OUT1, OUT2, EV1, EV2, EV3 in RUN screen.

Symbol	Parameter	Setting range	Display	Unit	Default
O.STS	Output Status	OFF, ON	Always	ABS	OFF

4-3-7 PV Display High, Low Limit

- Set the high and low limits of PV display in the front PV FND.

Symbol	Parameter	Setting range	Display	Unit	Default
DSP.H	Display High Limit	EU(-5.0 ~ 105.0%) (DSP.L < DSP.H)	Always	EU	EU(105.0%)
DSP.L	Display Low Limit				EU(-5.0%)

4-3-8 PASSWORD

- Register the PASSWORD.

Symbol	Parameter	Setting range	Display	Unit	Default
U.PWD	User Password	0 ~ 9999	Always	ABS	0



Precaution

- Be sure not to forget the PASSWORD.
- When the PASSWORD is lost. In this case, request a service to Samwontech.

4-3-9 Initialization of the controller

- Setting INIT = ON will initialize all the parameters except those in G.COM.

Symbol	Parameter	Setting range	Display	Unit	Default
INIT	Parameter Initialization	OFF, ON	Always	ABS	OFF

4-4. Communication (G.COM)

4-4-1 Protocol selection

- Select a Protocol to use.
- Select PCC0 for PC Link or select PCC1 for PC Link with sum check.

Symbol	Parameter	Setting range	Display	Unit	Default
COM.P	Communication Protocol	PCC0, PCC1, MBS.A, MBS.R, SYN.M	/RS Option	ABS	PCC1

4-4-2 Baud rate

- Set the baud rate, communication speed.

Symbol	Parameter	Setting range	Display	Unit	Default
BAUD	Baud Rate	4800, 9600, 19.2K, 38.4K	/RS Option	ABS	9600

4-4-3 Parity

- Set the parity.

Symbol	Parameter	Setting range	Display	Unit	Default
PRTY	Parity	NONE, EVEN, ODD	/RS Option	ABS	NONE

4-4-4 Stop Bit

- Set the stop bit.

Symbol	Parameter	Setting range	Display	Unit	Default
S.BIT	Stop Bit	1, 2	/RS Option	ABS	1

4-4-5 Data Length

- Set the data length.

Symbol	Parameter	Setting range	Display	Unit	Default
D.LEN	Data Length	7, 8	/RS option COM.P = PCC0, PCC1, SYN.M, SYN.S	ABS	8

4-4-6 Communication Address

- Set the communication address. Networking is available up to 31 ea max.

Symbol	Parameter	Setting range	Display	Unit	Default
ADDR	Address	1 ~ 99	/RS Option	ABS	1

4-4-7 Response Time

- Set the response time.

Symbol	Parameter	Setting range	Display	Unit	Default
RP.TM	Response Time	0 ~ 10 (x10ms)	/RS Option	ABS	0

4-5. Auto Tuning (G.AT)

**NOTE** Auto Tuning

- Auto tuning is a strong function that the controller tests the characteristics of the control system, and calculates the optimal values of PID parameters.
- During auto tuning the controller makes ON/OFF control output 2.5 cycles, measure the PV response of the control system with a limit cycle method and calculate the P, I, D value with the oscillation data.
- While a program is running and PV is kept around the SP, Auto tuning can be started. After tuning, the resultant P,I,D parameters of corresponding zone are automatically set.

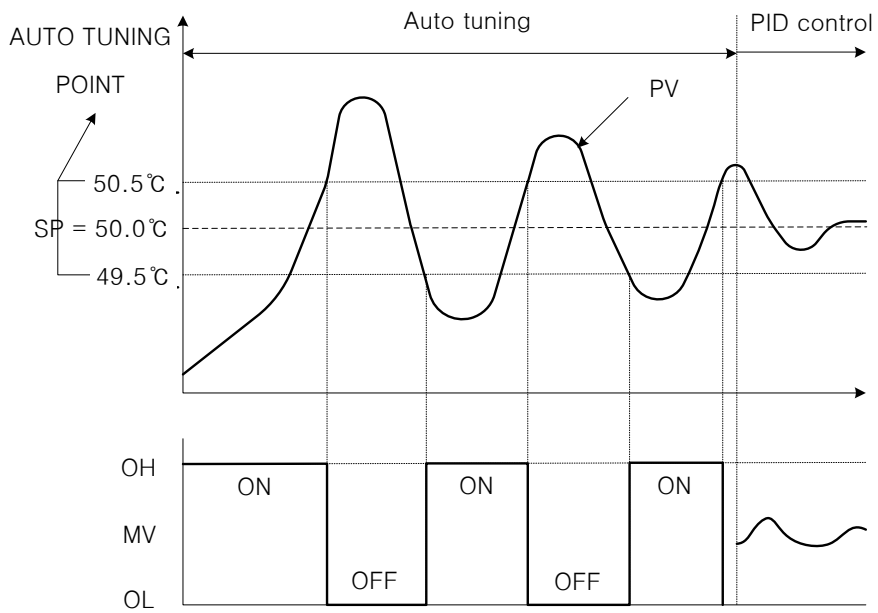
▪ Auto tuning procedure with a set point	
Parameter Setting	<ul style="list-style-type: none"> ▶ IN-T = PtC (RTD: -50.00°C ~ 150.00°C) ▶ AUTO TUNING POINT = EUS 0.25%(0.5°C) ▶ SP = 50.0°C ▶ OL = 0.0% ▶ OH = 100.0%
Tuning Procedure	

4-5-1 Auto tuning (SP series)

- Make auto tuning start by setting AT = ON.

Symbol	Parameter	Setting range	Display	Unit	Default
AT	Auto Tuning	OFF, ON	During RUN	ABS	OFF

**AT GAIN(Auto Tuning Gain)**

- A parameter to adjust the gain of MV with respect to PID.
 - ☞ Generally, use the value obtained after auto tuning.
- To adjust the characteristics of control system, AT GAIN can be set manually.
 - ① If AT GAIN < 1.0, RESPONSE is fast, but PV hunting may occur.
 - ② If AT GAIN > 1.0, OVERSHOOT decreases, RESPONSE becomes slow.

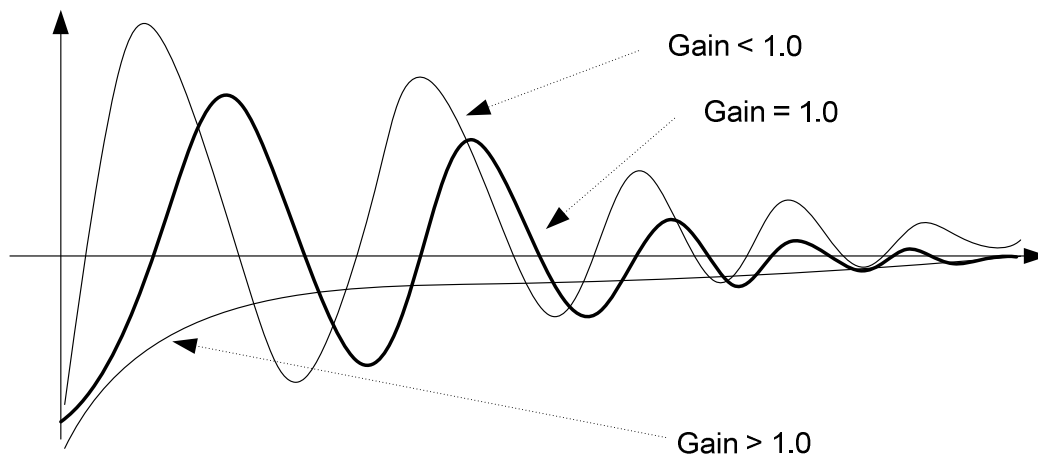

4-5-2 GAIN setting

- A parameter that determines the ratio between PID and MV. A small AT-G value makes the response fast and a large AT-G value is favorable for stable control but it takes long time to reach the target SP.

Symbol	Parameter	Setting range	Display	Unit	Default
AT-G	Auto Tuning Gain	0.1 ~ 10.0	Always	ABS	1.0



Starting Auto tuning and stopping it

■ Starting

- ① Check the control system, PV input and heater power

The Status should be in RUN mode. If the controller is in ready mode, enter a RUN mode pressing [^1] or [√2] key 1 sec or longer.

- ③ Set the AT parameter ON.

■ Stopping

Auto tuning stops automatically. But by setting AT=OFF or setting Ready mode, AT process will be interrupted.



Cautions

- AT can be done normally under controllable system condition (heater, sensor).
- AT can be started at RUN mode and when PV is in a normal range.
- At an abnormal situations, an Interruption of power or sensor burn-out during AT, AT will stop without changing PID parameters.
- The number of limit cycle or time can be different depending on the control system.
- MV will be ON and OFF for several times for limit cycle operation during AT procedure.
- In a special control system, optimal PID value cannot be obtained with AT. At this time, a user should adjust P, I, D value manually.

4-6. Alarm (G.ALM)

Table 4. Types of Alarm

NO	Display	Type	Direction		Standby		ON Condition	OFF Condition
			Fwd.	Rev.	No	Yes		
1	AH.F	Upper-limit PV	<input checked="" type="checkbox"/>		<input checked="" type="checkbox"/>		$PV \geq ALn$	$PV < (ALn - An.DB)$
2	AL.F	Lower-limit PV	<input checked="" type="checkbox"/>		<input checked="" type="checkbox"/>		$PV \leq ALn$	$PV > (ALn + An.DB)$
3	DH.F	Upper-limit Deviation	<input checked="" type="checkbox"/>		<input checked="" type="checkbox"/>		$(PV - SP) \geq ALn.H$	$(PV - SP) < (ALn.H - An.DB)$
4	DL.F	Lower-limit Deviation	<input checked="" type="checkbox"/>		<input checked="" type="checkbox"/>		$(PV - SP) \leq -ALn.L$	$(PV - SP) > (-ALn.H + An.DB)$
5	DH.R	Upper-limit Deviation		<input checked="" type="checkbox"/>	<input checked="" type="checkbox"/>		$(PV - SP) \geq ALn.H$	$(PV - SP) < (ALn.H - An.DB)$
6	DL.R	Lower-limit Deviation		<input checked="" type="checkbox"/>	<input checked="" type="checkbox"/>		$(PV - SP) \leq -ALn.L$	$(PV - SP) > (-ALn.H + An.DB)$
7	DO.F	Out of Deviation limits	<input checked="" type="checkbox"/>		<input checked="" type="checkbox"/>		$(PV - SP) \geq ALn.H$ \vee $(PV - SP) \leq -ALn.L$	$(PV - SP) < (ALn.H - An.DB)$ \wedge $(PV - SP) > (-ALn.H + An.DB)$
8	DI.F	In band of Deviation limits	<input checked="" type="checkbox"/>		<input checked="" type="checkbox"/>		$(PV - SP) \leq ALn.H$ \wedge $(PV - SP) \geq -ALn.L$	$(PV - SP) > (ALn.H - An.DB)$ \vee $(PV - SP) < (-ALn.H + An.DB)$
9	AH.R	Upper-limit PV		<input checked="" type="checkbox"/>	<input checked="" type="checkbox"/>		$PV \geq ALn$	$PV < (ALn - An.DB)$
10	AL.R	Lower-limit PV		<input checked="" type="checkbox"/>	<input checked="" type="checkbox"/>		$PV \leq ALn$	$PV > (ALn + An.DB)$
11	AH.FS	Upper-limit PV	<input checked="" type="checkbox"/>			<input checked="" type="checkbox"/>	$PV \geq ALn$	$PV < (ALn - An.DB)$
12	AL.FS	Lower-limit PV	<input checked="" type="checkbox"/>			<input checked="" type="checkbox"/>	$PV \leq ALn$	$PV > (ALn + An.DB)$
13	DH.FS	Upper-limit Deviation	<input checked="" type="checkbox"/>			<input checked="" type="checkbox"/>	$(PV - SP) \geq ALn.H$	$(PV - SP) < (ALn.H - An.DB)$
14	DL.FS	Lower-limit Deviation	<input checked="" type="checkbox"/>			<input checked="" type="checkbox"/>	$(PV - SP) \leq -ALn.L$	$(PV - SP) > (-ALn.H + An.DB)$
15	DH.RS	Upper-limit Deviation		<input checked="" type="checkbox"/>		<input checked="" type="checkbox"/>	$(PV - SP) \geq ALn.H$	$(PV - SP) < (ALn.H - An.DB)$
16	DL.RS	Lower-limit Deviation		<input checked="" type="checkbox"/>		<input checked="" type="checkbox"/>	$(PV - SP) \leq -ALn.L$	$(PV - SP) > (-ALn.H + An.DB)$
17	DO.FS	Out of Deviation limits	<input checked="" type="checkbox"/>			<input checked="" type="checkbox"/>	$(PV - SP) \geq ALn.H$ \vee $(PV - SP) \leq -ALn.L$	$(PV - SP) < (ALn.H - An.DB)$ \wedge $(PV - SP) > (-ALn.H + An.DB)$
18	DI.FS	In band of Deviation limits	<input checked="" type="checkbox"/>			<input checked="" type="checkbox"/>	$(PV - SP) \leq ALn.H$ \wedge $(PV - SP) \geq -ALn.L$	$(PV - SP) > (ALn.H - An.DB)$ \vee $(PV - SP) < (-ALn.H + An.DB)$
19	AH.RS	Upper-limit PV		<input checked="" type="checkbox"/>		<input checked="" type="checkbox"/>	$PV \geq ALn$	$PV < (ALn - An.DB)$
20	AL.RS	Lower-limit PV		<input checked="" type="checkbox"/>		<input checked="" type="checkbox"/>	$PV \leq ALn$	$PV > (ALn + An.DB)$
21	HBA	Heater Break Alarm	<input checked="" type="checkbox"/>		<input checked="" type="checkbox"/>		$HB.CD \leq HB.CS$	$HB.CD > (HB.CS + HB.DB)$

▪ AL : Alarm point, n : Alarm Number, ALn.H : Deviation upper-limit of Alarm n.



Alarm Operation

- PV Upper-limit Alarm operation (AH.F)

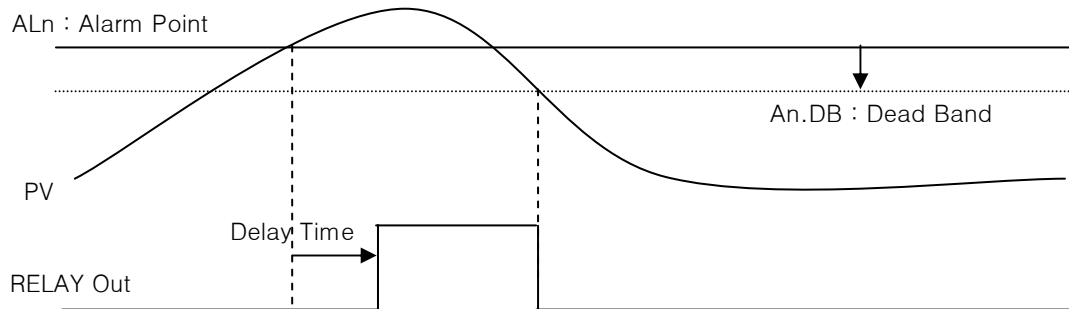

- PV Lower-limit Alarm operation (AL.F)

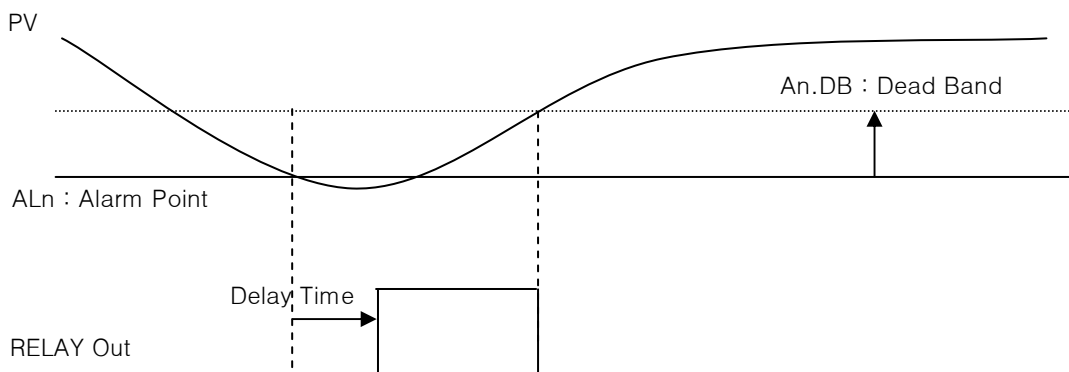

- Upper-limit Deviation Alarm operation (DH.F)

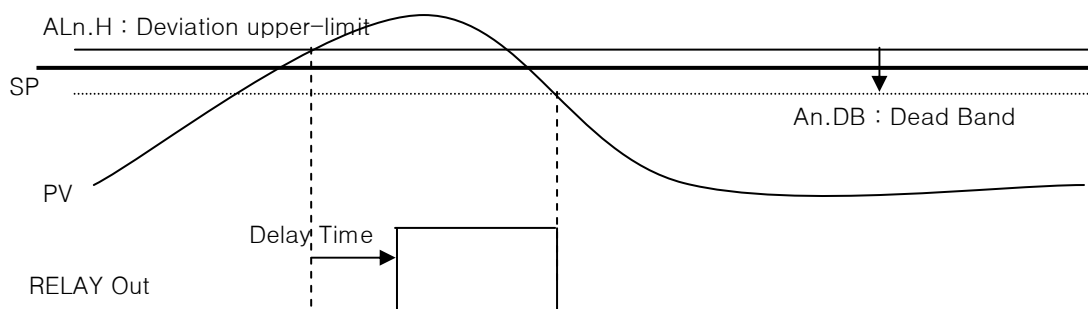

- Lower-limit Deviation Alarm operation (DL.F)

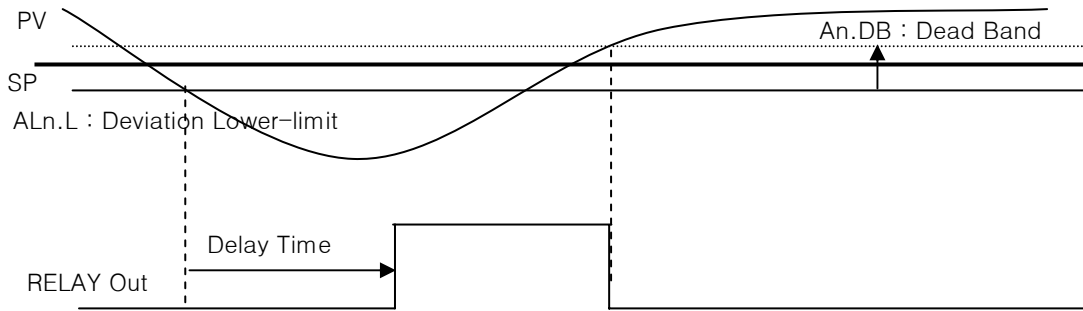

- In band Deviation limits Alarm operation (DI.F)

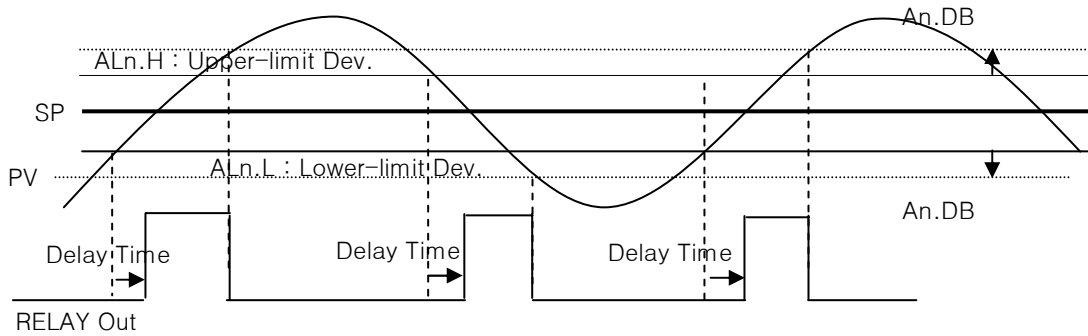

- Out of Deviation limits Alarm operation (DO.F)

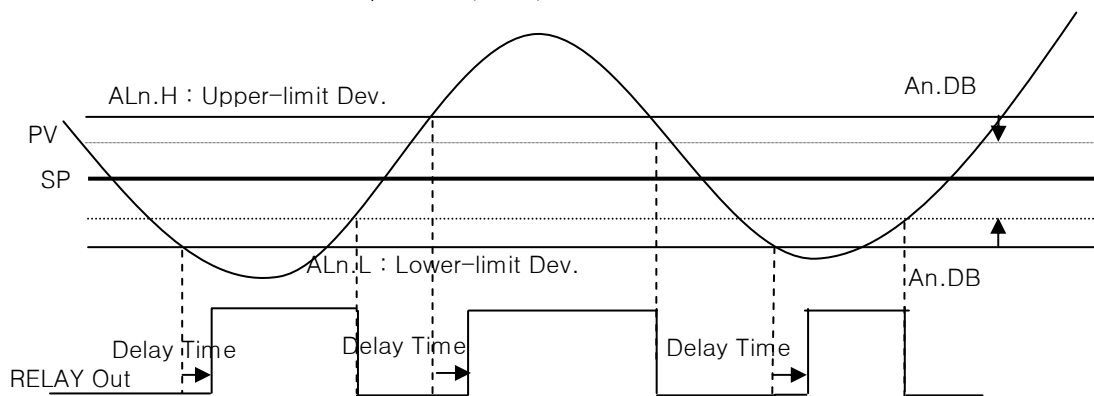

※ Output Direction mode

Forward (FWD) : ON when alarm condition, OFF when alarm off

Reverse (REV) : OFF when alarm condition, ON when alarm off

※ The condition of Standby

Power On

Changing of Alarm Kind

4-6-1 Alarm Kinds

- Set the alarm type of Alarm1,2,3.

Symbol	Parameter	Setting range	Display	Unit	Default
ALT1	Alarm 1 Type	Table 4. Types of Alarm	Always	ABS	AH.F
ALT2	Alarm 2 Type				
ALT3	Alarm 3 Type				

4-6-2 Alarm point

- Set the alarm point of Alarm1,2,3.

Symbol	Parameter	Setting range	Display	Unit	Default
AL1	Alarm 1 Set Value	EU(-100.0 ~ 100.0%)	Alarm type is not a Dev.	EU	EU(100.0%)
AL2	Alarm 2 Set Value				
AL3	Alarm 3 Set Value				

4-6-3 High/Low Deviation Alarm

- Set high and low deviation of Alarm1,2,3.

Symbol	Parameter	Setting range	Display	Unit	Default
AL1.H	Alarm 1 Set High Deviation	EUS(-100.0 ~ 100.0%)	Alarm type is a Dev. Type	EUS	EUS(0.0%)
AL1.L	Alarm 1 Set Low Deviation				
AL2.H	Alarm 2 Set High Deviation				
AL2.L	Alarm 2 Set Low Deviation				
AL3.H	Alarm 3 Set High Deviation				
AL3.L	Alarm 3 Set Low Deviation				

4-6-4 Dead Band

- Set the dead band of Alarm1,2,3.

Symbol	Parameter	Setting range	Display	Unit	Default
A1.DB	Alarm 1 Dead Band	EUS(0.0 ~ 100.0%)	Always	EUS	EUS(0.5%)
A2.DB	Alarm 2 Dead Band				
A3.AB	Alarm 3 Dead Band				

4-6-5 Delay Time

- Set the delay time of Alarm1,2,3.

Symbol	Parameter	Setting range	Display	Unit	Default
A1.DY	Alarm 1 Delay Time	0.00 ~ 99.59 mm.ss	Always	TIME	0 sec
A2.DY	Alarm 2 Delay Time				
A3.DY	Alarm 3 Delay Time				

4-7. PID Group

**NOTE** Anti reset wind-up (ARW)

- ARW is an effective function to minimize the influence of an external perturbation or disturbance.
- When I=0 in PID parameter, ARW will not work.
- MV estimation in PID control : $MV = P$ (proportional) + I (integration term) + D (derivative term)

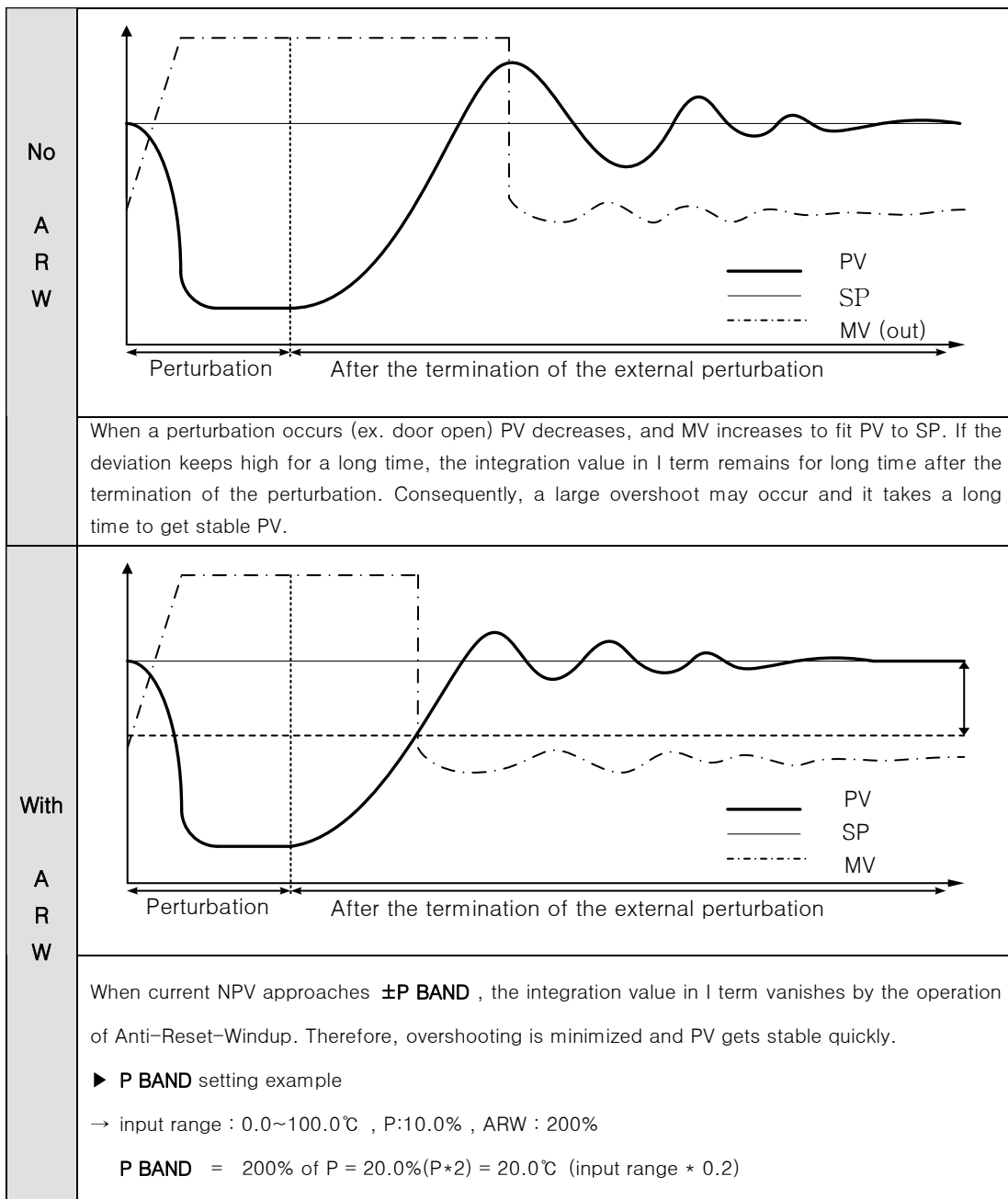

4-7-1 ARW (Anti Reset Wind-up)

- Set the deviation band to prevent over-integration.

Symbol	Parameter	Setting range	Display	Unit	Default
ARW	Anti-Reset Wind-Up	AUTO(0.0) ~ 200.0%	Always	%	100.0%

4-7-2 Control Mode

- Select a mode of PID control.

D.DV : MV change rate is small. Overshoot is small but it takes a bit long time to reach a TSP.

D.PV : MV change rate is large. Overshoot may be large and PV approaches TSP shortly.

Symbol	Parameter	Setting range	Display	Unit	Default
C.MOD	Control Mode	D.PV, D.DV	Always	ABS	D.PV

**NOTE** Control Mode

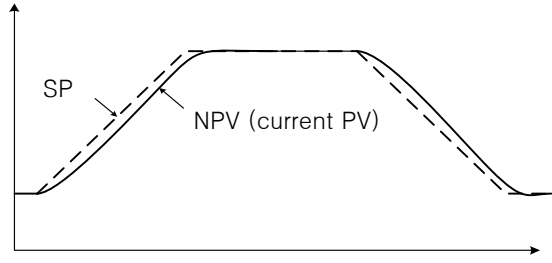
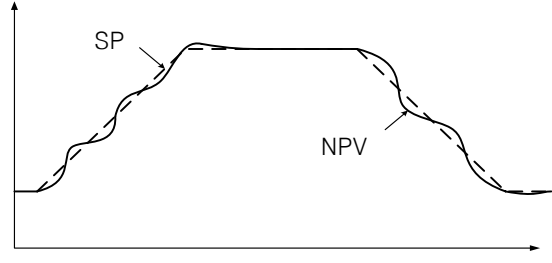
D.DV mode	Description
	<ul style="list-style-type: none"> In D.DV mode, MV changes slowly. Overshoot is small but the delay may appear to reach SP. It is suitable for a system which shows sensitive response to MV.
D.PV mode	Description
	<ul style="list-style-type: none"> In D.PV mode, MV changes quickly. Overshoot may occur but the time to reach the TSP is shorter. It is suitable for a system which shows slow response to MV.

4-7-3 Fuzzy Function

- Set Fuzzy Function active or disabled.

Symbol	Parameter	Setting range	Display	Unit	Default
FUZY	Fuzzy Select	OFF, ON	Always	ABS	OFF



Fuzzy Operation

- When the variation of load power is great, or SP is changed frequently, overshooting appears generally. The Fuzzy function is effective to suppress the overshooting.
- Internal working sequence of FUZZY function
 - ① When PV approaches SP, The calculation of SUPER SP is carried out.
 - ② Assuming this Super SP as SP, MV is estimated.
- ☞ **Overshooting is suppressed by FUZZY function.**

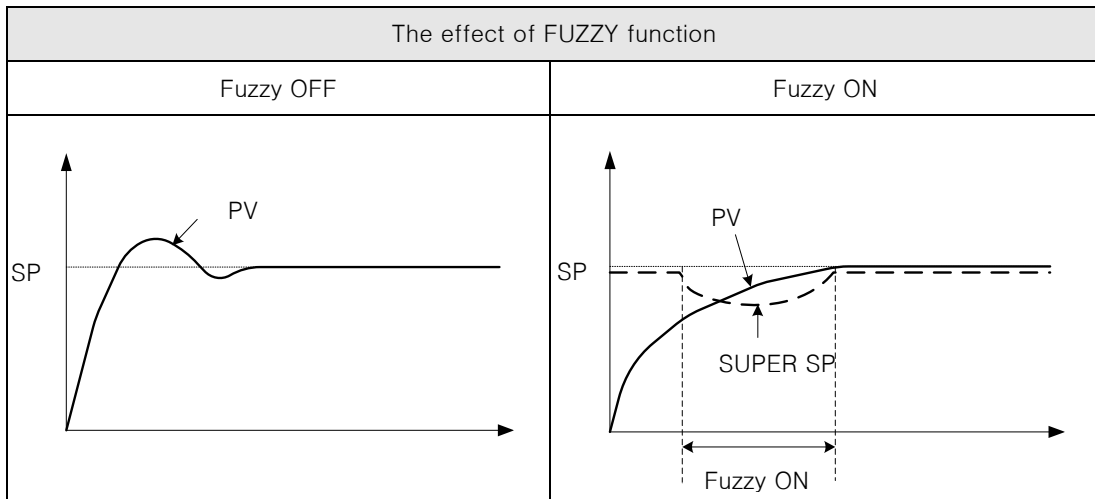

4-7-4 PID Number

- Select the PID number to use.

Symbol	Parameter	Setting range	Display	Unit	Default
PID	PID Number	MENU, 1 ~ 4	Always	ABS	MENU

4-7-5 Proportional band

- Set the Proportional band of PID.

Symbol	Parameter	Setting range	Display	Unit	Default
n.P	Heat Proportional Band	0.1 ~ 1000.0%	Always	%	10.0%

4-7-6 Integration time

- Set the Integration time of PID.

Symbol	Parameter	Setting range	Display	Unit	Default
n.I	Heat Integral Time	OFF, 1 ~ 6000 sec	Always	ABS	120 sec

4-7-7 Derivation time

- Set the Derivation time of PID.

Symbol	Parameter	Setting range	Display	Unit	Default
n.D	Heat Derivative Time	OFF, 1 ~ 6000 sec	Always	ABS	30 sec

4-7-8 Manual set value of Integration time

- If the Integration time (I) is "OFF", the setting value will be assigned to the I term in PID.

Symbol	Parameter	Setting range	Display	Unit	Default
n.MR	Manual Reset	-5.0 ~ 105.0%	I = 0	%	50.0%

4-7-9 PID zone setting

- Set the boundaries of 3 zone of PID.

Symbol	Parameter	Setting range	Display	Unit	Default
1.RP	Reference Point 1	$EU(0.0\%) \leq 1.RP \leq 2.RP$	PID = 1	EU	EU(33.3%)
2.RP	Reference Point 2	$1.RP \leq 2.RP \leq EU(100.0\%)$	PID = 2		EU(66.7%)

4-7-10 PID DEAD BAND

- When using Zone PID, set the hysteresis at the zone boundary.
- The hysteresis works when moving from zone 3 to zone 2 or from zone 2 to zone 1.

Symbol	Parameter	Setting range	Display	Unit	Default
RP.HY	Reference Hysteresis	EUS(0.0 ~ 10.0%)	PID = 3	EUS	EUS(0.3%)

4-7-11 Deviation value used in deviation PID

- Set the deviation value when using Deviation PID.

Symbol	Parameter	Setting range	Display	Unit	Default
RDV	Reference Deviation	EUS(0.0 ~ 100.0%)	PID = 4	EUS	EUS(0.0%)

**NOTE** PID Group

- PID Zone is determined by NPV. When PV oscillates around the zone boundaries 1.RP, 2.RP, PID set changes correspondingly. To prevent frequent change of PID set, the RP.HY can be set.

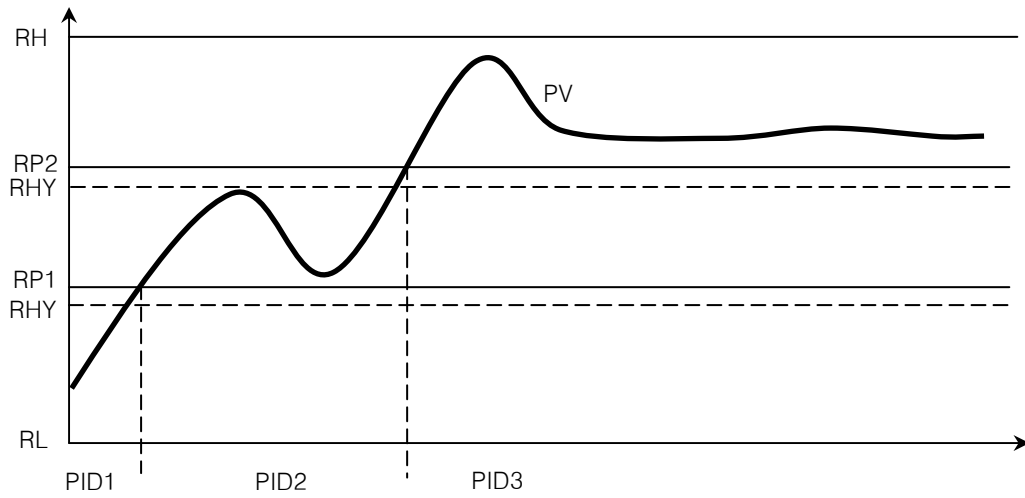

- Deviation PID (4.PID) may be used by setting RDV value. When $|PV-SP| > RDV$, 4.PID set is applied.

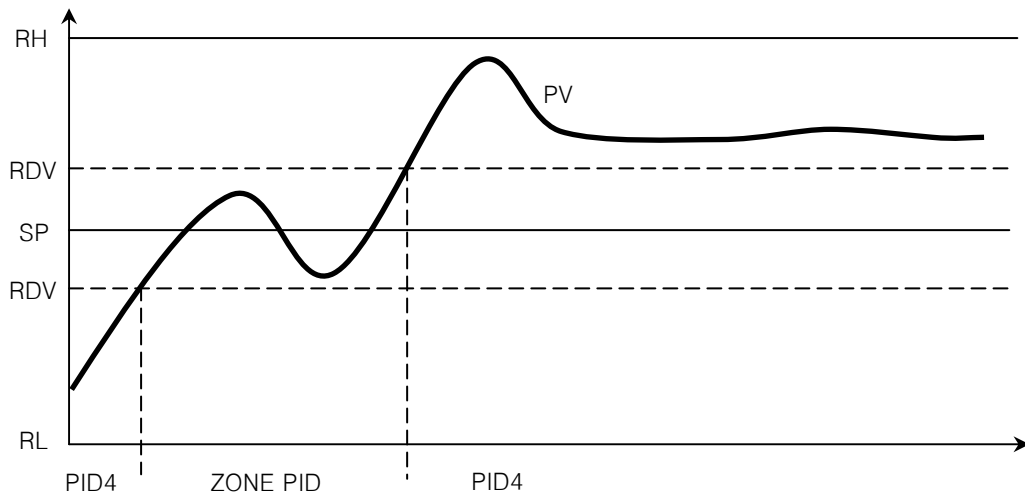

4-8. Program Group (PROG)



RUN Mode

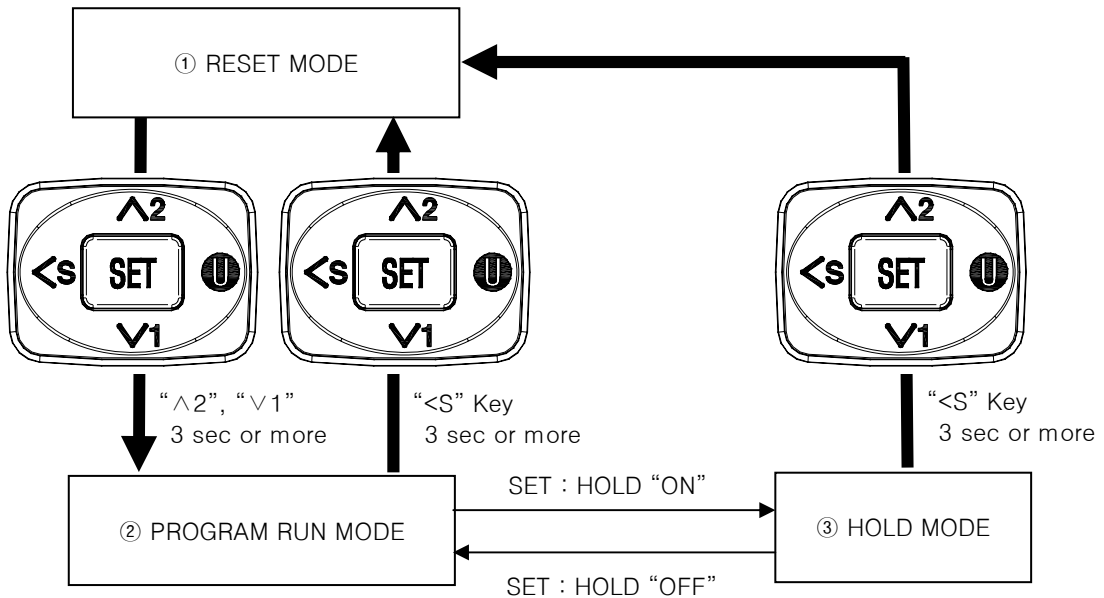

① RESET MODE

- SP : PROGRAM Reset SP = STOP 표시
- OUT : PO(Preset Out)
- KEY 조작 : Pressing " \wedge " KEY 3 seconds or more, pattern 1 program can be started.
: Pressing " \vee " KEY 3 seconds or more, pattern 2 program can be started.

② PROGRAM RUN MODE

- SP : the SP set by PROGRAM pattern
- OUT : PID control output
- KEY 조작 : Pressing "<" KEY 3 seconds, pattern run can be stopped. (RESET mode)
: Pressing SET KEY, one can execute HOLD, STEP function.

③ HOLD MODE

- SP : the SP of Program pattern when HOLD MODE started
(if HOLD is done in SOAK segment, HOLD SP can be changed.)
- OUT : PID control output



PROGRAM RUN Starting

– PROGRAM starting behavior is determined by STC value.

STC	PROGRAM Start Code
SSP	SSP (START SP) of each Program
PV	PV START (slope first)

1) SSP START

– Regardless of current PV, SP changes with the slope of $\frac{(TSP1 - SSP)}{n.TM1}$ from SSP to TSP1 (n=1,2)

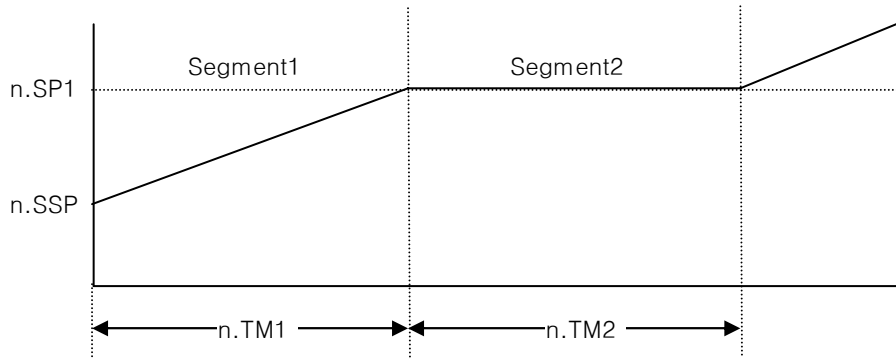

2) PV START

– If current PV is between SSP and SP1, the start point will be the point (TM, PV) in the pattern program. Assuming time has elapsed by TM and the program RUN goes with the same ramping rate in the first segment. Duration of Time signal is also affected.

– In PV START mode, the starting point is found out in the range to the first SOAK SEGMENT.

The rules are listed as following.

- ▶ If PV is less than SSP, the starting point is SSP.
- ▶ If there is a soak segment and PV is greater than the soak SP, the start point will be the beginning of the soak segment.
- ▶ Even if the slope is negative and PV is in the slope, the program starts at the point.

※ Following detailed description is based on ascending slope. The relative positions of the points are reversed for a descending slope.

① The second segment is a soak segment.

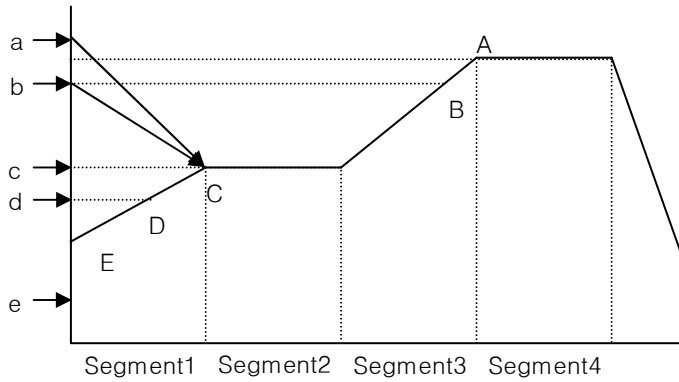

PV at the beginning of program run (PV)	Starting Point
a	C
b	C
c	C
d	D
e	E(SSP)

② The third segment is a soak segment.

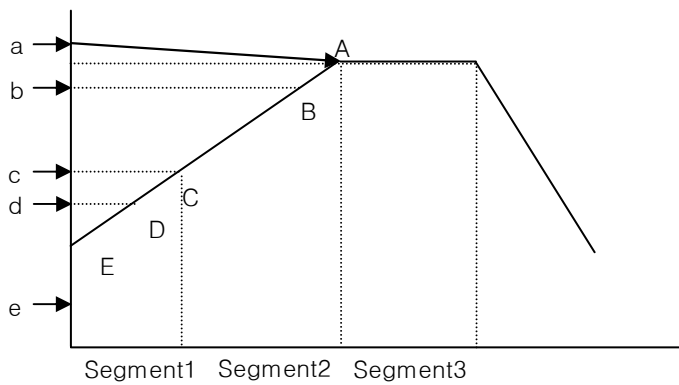

PV at the beginning of program run (PV)	Starting Point
a	A
b	B
c	C
d	D
e	E(SSP)

③ There is no soak segment

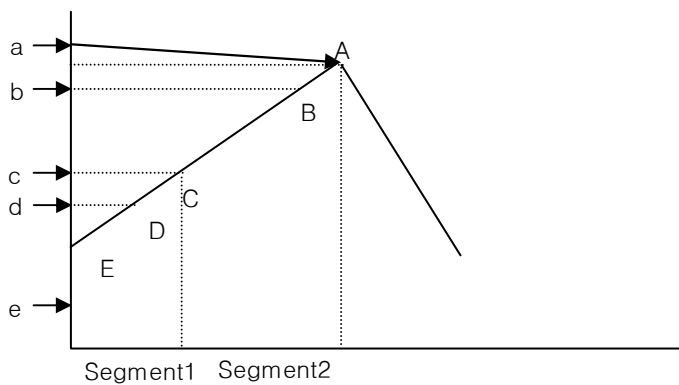

PV at the beginning of program run (PV)	Starting Point
a	A
b	B
c	C
d	D
e	E(SSP)

④ There are only ramping segments

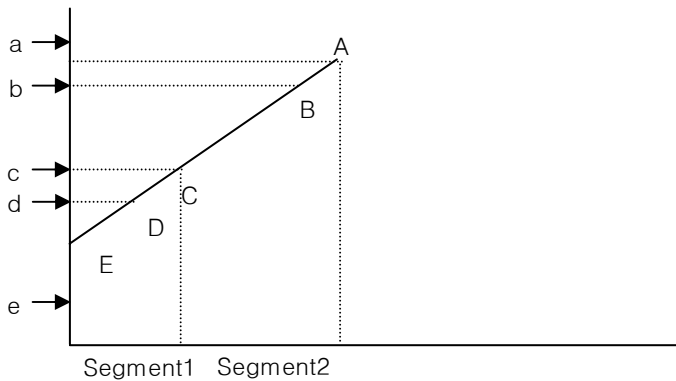

PV at the beginning of program run (PV)	Starting Point
a	Not start
b	B
c	C
d	D
e	E(SSP)



PROGRAM RUN operation

1) TIME SIGNAL

– Time signal of each segment operates as the ON/OFF value set in the segment.

2) WAIT operation

– At the end of a segment, a certain amount of deviation is shown in common cases. It can be a problem to proceed to the next segment with large deviation. The WAIT function is useful in this case and this can be activated by setting waiting zone (W.ZON) and waiting time (W.TM). The progressing of program is in a waiting state until the deviation becomes less than W.ZON and the maximum waiting time can be set by W.TM. If W.TM = 00.00, waiting is kept endlessly until the deviation becomes less than W.ZON.



HOLD operation

- Changing into the HOLD mode from RUN mode, the proceeding of program will stop and be kept in a holding state.
- Returning to RUN mode from HOLD can be done by several means such as key operation, communication, and external DI signals.

- When HOLD mode is in a soak segment, H.SP (HOLD SP) and H.TM(HOLD TIME) can be modified. When HOLD mode is off, RUN is going on with TSP = H.SP, segment time = H.TM.
(However the original program pattern will not be changed after changing H.SP, H.TM .



STEP operation

STEP is the function which let the program process move to the next segment at once. STEP function can be performed by parameter setting, communication. Wait function (W.ZON, W.TM) will be ignored when STEP action is done. When reaching the last segment, next action is determined by link code parameters (1.LC, 2.LC).



Power source interruption

- After a power interruption while RUN, the controller mode is determined by DISL, DI1, DI2 signals.
 - DISL= OFF,1 : RESET when the power recovers (ON).
 - DISL= 2
 - DI1 OFF : RESET when POWER ON.
 - DI1 ON : RUN the Pattern selected by DI2.
 - DI2 OFF : select pattern 1.
 - DI2 ON : select pattern 2.

4-8-1 Time Unit (TMU)

- Select the time unit used in pattern programming.

Symbol	Parameter	Setting range	Display	Unit	Default
TM.U	Time Unit	HH.MM, MM.SS	Always	ABS	HH.MM

4-8-2 Start Code Set point (STC)

- Select the program starting mode above mentioned.

Symbol	Parameter	Setting range	Display	Unit	Default
STC	Start Code	SSP, PV	Always	ABS	PV

4-8-3 Waiting Zone (W.ZON)

- Set the waiting zone of WAIT function, the maxim deviation at which the waiting can be stopped.
- Waiting operates only at the transition from ramp segment to soak segment
- Setting W.ZON = OFF(0.0), WAIT function does not operate.

Symbol	Parameter	Setting range	Display	Unit	Default
W.ZON	Wait Zone	OFF, EUS[[0.0% + 1 digit] ~ 100.0%)	Always	EUS	OFF

4-8-4 Wait Time (W.TM)

- Set the maximum waiting time for WAIT function.
- Setting W.TM = OFF (0.0), waiting time is endless until the deviation goes within waiting zone.

Symbol	Parameter	Setting range	Display	Unit	Default
W.TM	Wait Time	OFF, 0.01 ~ 99.59	Always	TM.U	OFF

4-8-5 Link Code (.LC)

- Decide the action after the end of the program run.

Symbol	Parameter	Setting range	Display	Unit	Default
n.LC	Link Code	RST, HOLD, PTN1, PTN2	Always	ABS	RST

Table 5. LINK CODE

LINK CODE	Action of controller at the end of a program run
RST	RESET(STOP) mode
HOLD	Hold mode with TSP of the last segment until going to RESET mode by pressing <S key
PTN1	PTN1(pattern 1) RUN (if current pattern is PTN1, endless cycling goes)
PTN2	PTN2(pattern 2) RUN (if current pattern is PTN2, endless cycling goes)

4-8-6 Starting Set Point (.SSP)

- Set START SET POINT, SSP.
- SSP is used only when STC=SSP.

Symbol	Parameter	Setting range	Display	Unit	Default
n.SSP	Start SP	EU(0.0 ~ 100.0%)	Always	EU	EU(0.0%)

4-8-7 Target Set Point of Segment

- Set the target set point (TSP) of a segment.
- The maximum number of segment TSP is 15 (1~F).

Symbol	Parameter	Setting range	Display	Unit	Default
n.SP1	Target SP1	EU(0.0 ~ 100.0%)	Always	EU	EU(0.0%)
:	:				
n.SPF	Target SPF				

4-8-8 Segment Time

- Set the running time of segments.

Symbol	Parameter	Setting range	Display	Unit	Default
n.TM1	Segment Time 1	OFF, 0.01 ~ 99.59	Always	TM.U	OFF
:	:				
n.TMF	Segment Time F				

4-8-9 Time Signal

- Set the ON/OFF state of TS (Time Signal).
- With TS="ON", The Time Signal is ON during the segment time.

Symbol	Parameter	Setting range	Display	Unit	Default
n.TS1	Time Signal 1	OFF, ON	Always	ABS	OFF
:	:				
n.TSF	Time Signal F				

4-8-10 Number of Segment Repeat

- Set the REPEAT number while repeating segment block defined by REN and RST.

Symbol	Parameter	Setting range	Display	Unit	Default
n.RPT	Segment Repeat	0 (infinite) ~ 999	Always	ABS	1

4-8-11 Last segment number of repeating segment group

- Set the last segment number while segment block repeating.
- "0" : Do not use segment block repeating function

Symbol	Parameter	Setting range	Display	Unit	Default
n.REN	Repeat End Segment	$0, 1 \leq n.RST \leq n.REN \leq 15$	Always	ABS	0

4-8-12 First segment number of repeating segment group

- Set the first segment number while segment block repeating
- "0" : Do not use the repeating function.

Symbol	Parameter	Setting range	Display	Unit	Default
n.RST	Repeat Start Segment	$0, 1 \leq n.RST \leq n.REN \leq 15$	Always	ABS	0

4-9. Inner Signal Group (G.IS)

4-9-1 Type to be referenced (.IST)

- Set the reference parameter of Inner signal action.

Symbol	Parameter	Setting range	Display	Unit	Default
1.IST	Inner Signal Type 1	NSP, NPV, TSP	Always	ABS	NPV
2.IST	Inner Signal Type 2				

4-9-2 Out or In band (.ISB)

- Select the domain of a band of IS operation, in-band (I.BD) or out-of-band (O.BD).

Symbol	Parameter	Setting range	Display	Unit	Default
1.ISB	Inner Signal Band 1	I.BD, O.BD	Always	ABS	I.BD
2.ISB	Inner Signal Band 2				

4-9-3 High/Low limits of band (.ISH, .ISL)

- Set the high limit (.ISH) and low limit (.ISL) of the IS band.

Symbol	Parameter	Setting range	Display	Unit	Default
1.ISH	Inner Signal Range High 1	EU(0.0 ~ 100.0%) (1.ISL ≤ 1.ISH)	Always	EU	EU(0.0%)
1.ISL	Inner Signal Range Low 1				
2.ISH	Inner Signal Range High 2	EU(0.0 ~ 100.0%) (2.ISL ≤ 2.ISH)			
2.ISL	Inner Signal Range Low 2				

4-9-4 Delay Time (.ISD)

- Set the delay time for IS output.

Symbol	Parameter	Setting range	Display	Unit	Default
1.ISD	Inner Signal Delay 1	OFF, 0.01 ~ 99.59	Always	TM.U	OFF
2.ISD	Inner Signal Delay 2				



Examples of Inner Signal Operation

[Example 1]

- INPUT = 0.0 ~ 100.0 → EUS 0.5% = 0.5

OPER.MODE	TYPE	RANGE LOW	RANGE HIGH	DIRECT	DELAY TIME
PROG	PV	30.0°C	50.0°C	IN BAND	00.00

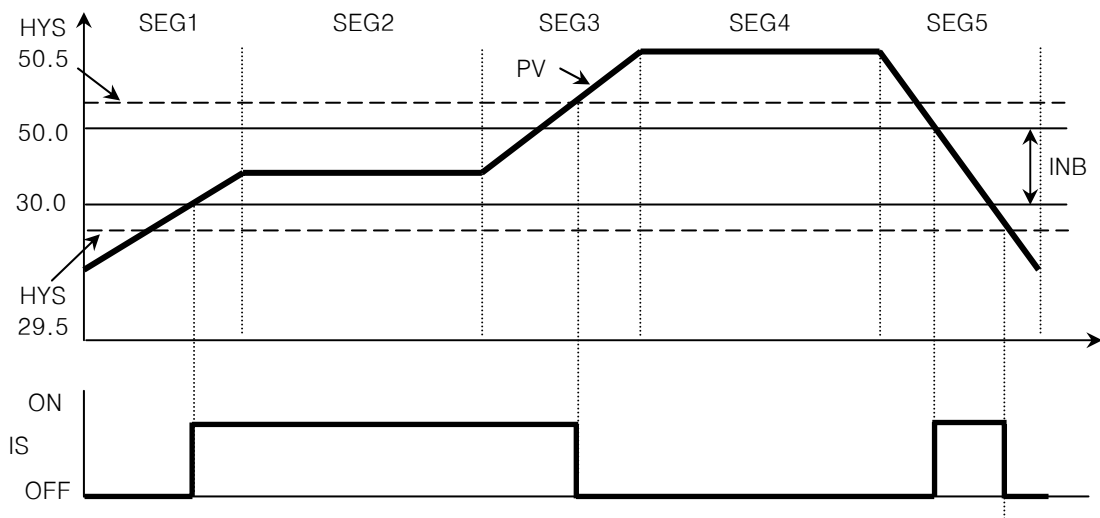

[Example 2]

▪ INPUT = 0.0 ~ 100.0 → EUS 0.5% = 0.5

OPER.MODE	TYPE	RANGE LOW	RANGE HIGH	DIRECT	DELAY TIME
PROG	PV	30.0°C	50.0°C	OUT BAND	00.00

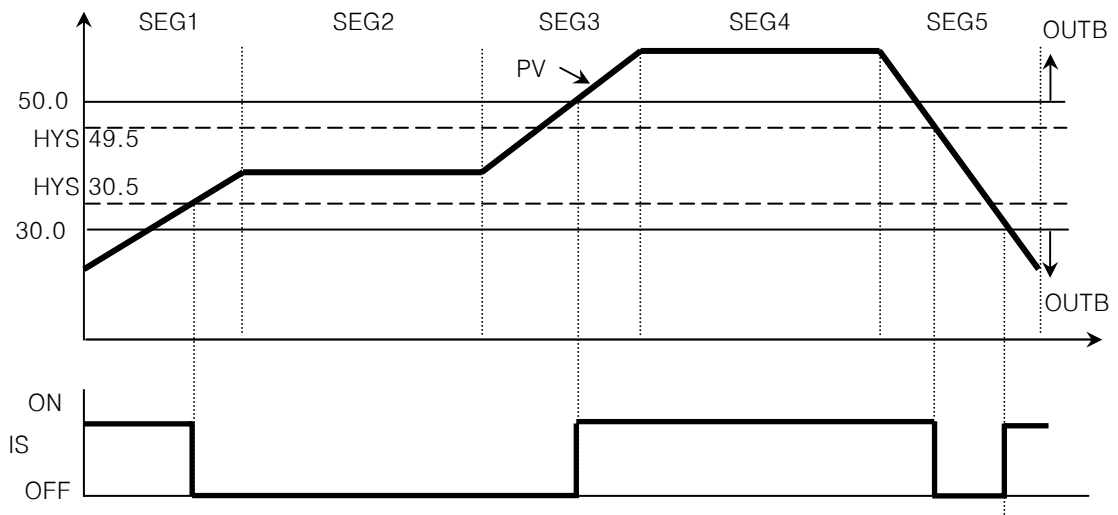

[Example 3]

- INPUT = 0.0 ~ 100.0

OPER.MODE	TYPE	RANGE LOW	RANGE HIGH	DIRECT	DELAY TIME
PROG	SP	30.0°C	50.0°C	IN BAND	00.10

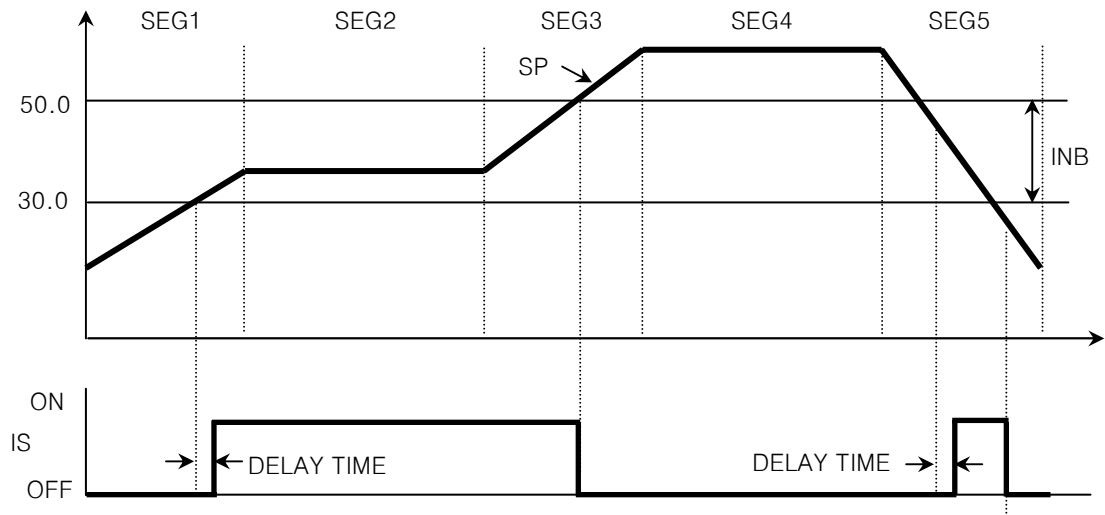

[Example 4]

- INPUT = 0.0 ~ 100.0 → EUS 0.5% = 0.5

OPER.MODE	TYPE	RANGE LOW	RANGE HIGH	DIRECT	DELAY TIME
PROG	TSP	30.0°C	50.0°C	OUT BAND	00.00

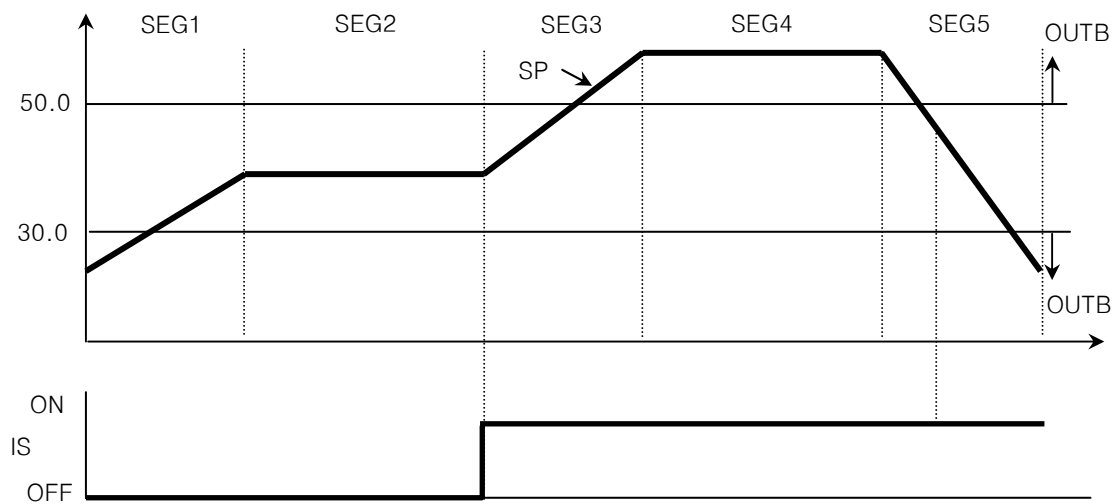

4-10. Retransmission Group (G.RET)

4-10-1 Type of retransmission (RET)

- Set the type of retransmission signal.

Symbol	Parameter	Setting range	Display	Unit	Default
RET	Retransmission Type	LPS, PV, SP, MV	Always	ABS	PV

**NOTE** Retransmission Output

- 1) PV : 3.2mA ~ 20.8mA

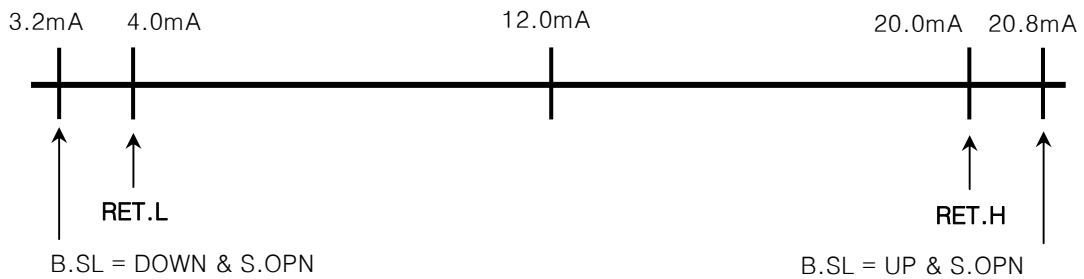

- 2) SP : 4.0mA ~ 20.0mA

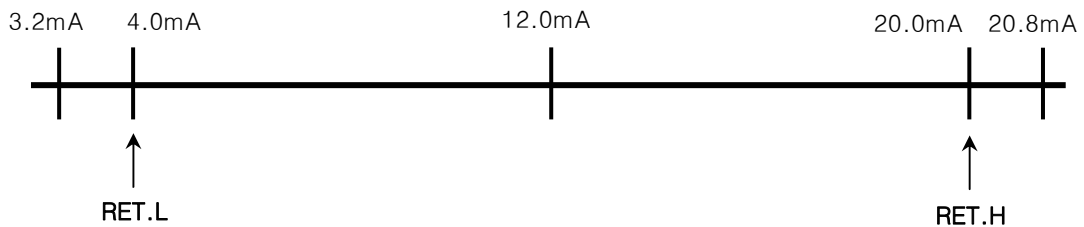

- 3) MV : 3.2mA ~ 20.8mA

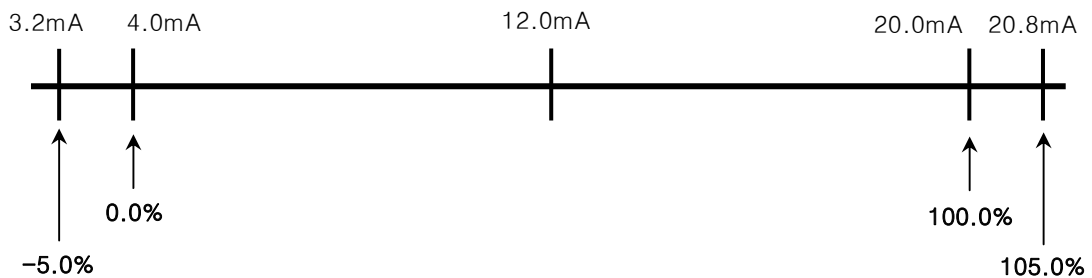

4-10-2 High and low limits (RETH, RETL)

- Set high and low limits of retransmission.

Symbol	Parameter	Setting range	Display	Unit	Default
RET.H	Retransmission High Limit	TC, RTD : IN.RL ~ IN.RH DCV : IN.SL ~ IN.SH	RET = PV or	EU	IN.RH(TC,RTD) IN.SH(DCV)
RET.L	Retransmission Low Limit	(RET.L < RET.H)	RET = SP		IN.RL(TC,RTD) IN.SL(DCV)

**NOTE** Setting Example

PV range = $-100 \sim 200^{\circ}\text{C}$, output : 4~20mA,

Set RET = PV → PV is retransmitted.

Set RET.H= 200.0

Set RET.L= -100.0

4-11. Heater Break Alarm (HBA)

4-11-1 Heater Current Display

- Display the current of the heater.

Symbol	Parameter	Setting range	Display	Unit	Default
HB.CD	Heater Break Current Display	Display only	HBA option	ABS	-

4-11-2 Heater Current Alarm Point

- Set the alarm point of heater current.

Symbol	Parameter	Setting range	Display	Unit	Default
HB.CS	Heater Break Alarm Current	OFF, 1 ~ 50A	HBA option	ABS	OFF

4-11-3 Dead band

- Set dead band of heater break alarm.

Symbol	Parameter	Setting range	Display	Unit	Default
HB.DB	Heater Break Alarm Dead Band	0 ~ 10A	HBA option	ABS	0



NOTE Error Display and Correction

NO.	Time	Display	Cause of Error	Correction
1	Power ON	E.SYS	Incomplete inspection	Ask for repairs.
2	Operating	E.RJC	Abnormal temperature of terminal	Check the ambient temperature and make it suitable for operation condition.
3		PV Blinking	Incomplete inspection	Ask for repairs.
4		SP decimal point blinking	Communication error	Check the parameters in G.COM. Check the communication line.
5		S.OPN	Sensor burn-out, Wiring error, Wrong parameter set	Check the SENSOR. Check the wiring. Check input parameter setting.
6		E.AT	Auto tuning time out (over 27 hours)	Check the control system.
7		All blackout	Hardware damage	Check the power supply.
			ROM memory fail	Ask for repairs.

5. Communication

5-1. Outline of communication

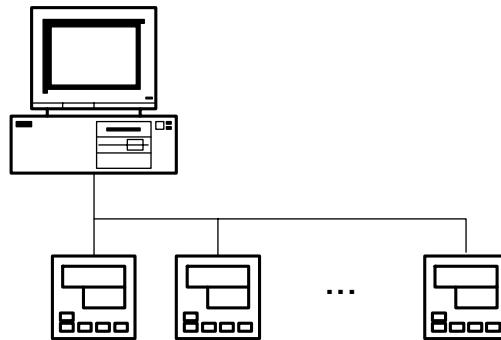
- NOVA series adopt RS485 communication method, Half-Duplex, 2 wire communication.
- A host computer can communicate with the controllers (up to 31 ea) through RS485 multi-drop network and using a protocol provided.



5-2. Wiring of communication

- RS485 : The wiring of NOVA Series and Master station is as following figure.

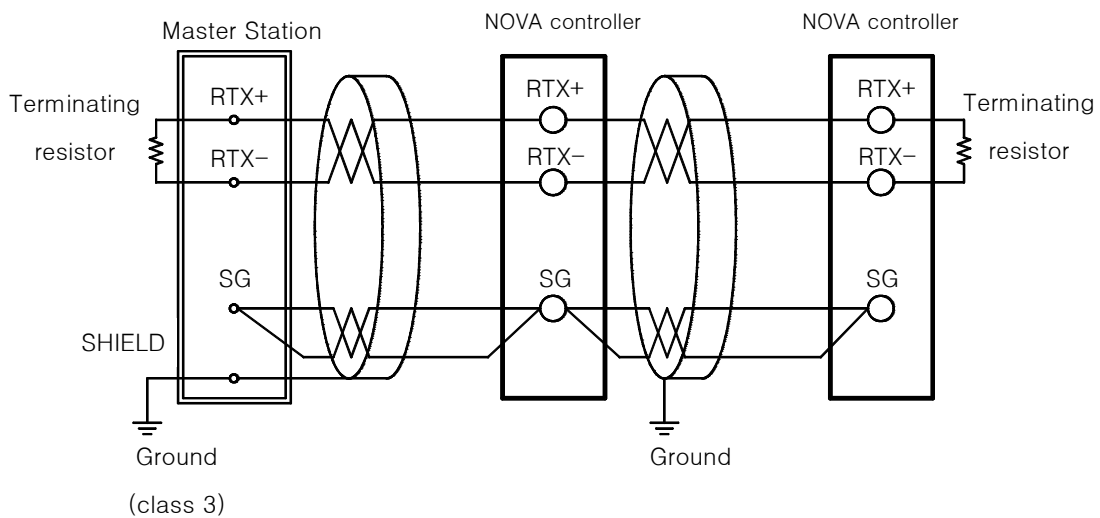

- Slave controllers can be connected to a master device by multi-drop networking.
- Be sure to connect two termination resistors (200Ω 1/4W) to both ends of the network.

- RS232 : The wiring between the controller and a host device.

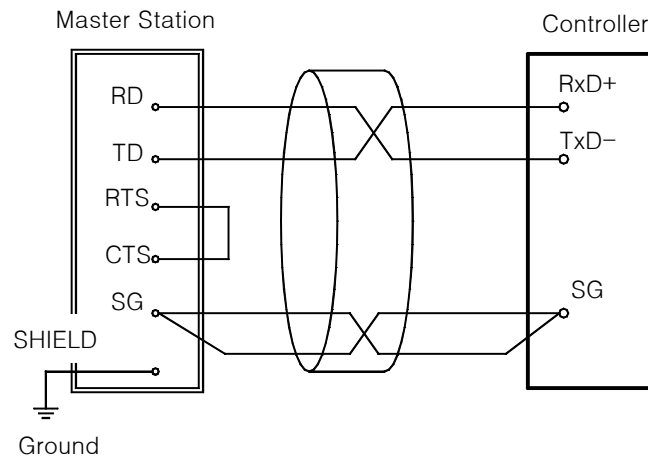

5-3. Communication parameters

- The parameters of communication setup.

Display	Parameter	Set value	Description	Default
COM.P	Protocol	0	Standard protocol	X
		1	Standard protocol + Check Sum	O
		2	MODBUS ASCII	X
		3	MODBUS RTU	X
		4	SYNC-Master	X
BAUD	Baud Rates	5	SYNC-Slave	X
		3	38400	X
		2	19200	X
		1	9600	O
PTRY	Parity	0	4800	X
		NONE	No parity	O
		EVEN	Even parity	X
SBIT	Stop Bit	ODD	Odd parity	X
		1	1 bit	O
DLEN	Data Length	2	2 bit	X
		7	7 bit	X
ADDR	Address	8	8 bit	O
		1 ~ 99	Address	1
RPTM	Response time	0 ~ 10	= Processing time + RPTM * 10msec	0

※ Data Length(D.LEN) : When the protocol is MODBUS, this is skipped.

5-4. Standard Protocol

- The standard protocol of NOVA series is composed of ASCII string. A user can read or write the contents of D-Register.
- There are two kinds of protocols which can be selected by COM.P parameter.
- The frame of standard protocol starts with STX and ends with CR LF.
- 'SUM' protocol (COM.P = 1) is a more sophisticated one which includes Check Sum as an error check.

① The Frame structure of standard protocol

STX	Address	Command	Data	CR	LF
0x02	1~99	Refer to each command		0x0D	0x0A

② The Frame structure of the SUM protocol

STX	Address	Command	Data	SUM	CR	LF
0x02	1~99	Refer to each command		Check Sum	0x0D	0x0A

- Check Sum is calculated as following.
 - 1) Add the ASCII code of characters from the character next to STX one by one up to the character prior to SUM.
 - 2) Represent the lowest one byte of the sum as a hexadecimal notation (2 characters).

5-4-1 Communication command

- There are several kinds of commands, general commands for read/write of D-register, information command for checking the controller version, and check command for inspection procedure.

① General Command

Command	Function
RSD	D-Register Sequential Read
RRD	D-Register Random Read
WSD	D-Register Sequential Write
WRD	D-Register Random Write
STD	D-Register Monitoring Set
CLD	D-Register Monitoring Call

② Information Command

Command	Function
AMI	Model, Version Information of the controller

③ Error Response

- When an Error occurs during communication, NOVA sends a frame as following.

Bytes	1	2	2	2	2	1	1
Frame	STX	Address	NG	Error Code	SUM	CR	LF

- SUM is used only when COM.P = "1"

(refer to Error Code : 5-4-4)

5-4-2 General command

5-4-2-1 Read Command

① RSD Command

- RSD Command is used to read a part of D-Register sequentially. It is necessary to set the number of registers to read and starting address.

Frame Format

# Bytes	Frame
1	STX
2	Address
3	RSD
1	,
2	Number
1	,
4	D-Register
2	SUM
1	CR
1	LF

1~32
starting D-Register address

Normal Response Format

# Bytes	Frame
1	STX
2	Address
3	RSD
1	,
2	OK
1	,
4	Data_1
1	,
...	...
1	,
4	Data_n
2	SUM
1	CR
1	LF

Hexadecimal 16bit Word (4 character)

ex) Reading PV(D0001), SP(D0002) D-Register

- Sending Frame : [stx]01RSD,02,0001[cr][lf]
- Sending Frame (Check Sum) : [stx]01RSD,02,0001C5[cr][lf]

If PV, SP are 50.0, 30.0 respectively,

- Receiving Frame : [stx]01RSD,OK,01F4,012C[cr][lf]
- Receiving Frame(Check Sum) : [stx]01RSD,OK,01F4,012C19[cr][lf]

※ Converting 4digit hexadecimal number to decimal number

- ① Radix conversion : 01F4 (hexadecimal) → 500(decimal)
- ② Multiply factor (decimal point) : 500*0.1 → 50.0

② RRD Command

- RRD Command is used to read D-Registers in randomly. It is necessary to set the number of registers to read and the addresses of the registers.

Frame Format

Bytes	Frame
1	STX
2	Address
3	RRD
1	,
2	Number
1	,
4	D-Register_1
1	,
...	...
1	,
4	D-Register_n
2	SUM
1	CR
1	LF

1~32

First D-Register address

Normal Response Format

Bytes	Frame
1	STX
2	Address
3	RRD
1	,
2	OK
1	,
4	Data_1
1	,
...	...
1	,
4	Data_n
2	SUM
1	CR
1	LF

16bit Word (4 character)

hexadecimal notation

ex) Reading PV(D0001), SP(D0002) D-Registers

- Sending Frame : [stx]01RRD,02,0001,0002[cr][lf]
- Sending Frame (Check Sum) : [stx]01RRD,02,0001,0002B2[cr][lf]

If D0001 = 50.0 and D0002 = 30.0

- Receiving Frame : [stx]01RRD,OK,01F4,012C[cr][lf]
- Receiving Frame (Check Sum) : [stx]01RRD,OK,01F4,012C18[cr][lf]

5-4-2-2 Write Command

① WSD Command

- WSD Command is used to write data to successive D-Registers. It is necessary to set the number of register, starting address, and array of data.

Frame Format

Bytes	Frame
1	STX
2	Address
3	WSD
1	,
2	number
1	,
4	D-Register
1	,
4	Data_1
1	,
...	...
1	,
4	Data_n
2	SUM
1	CR
1	LF

1~32

First D-Register address

16bit Word (4 character)

Normal Response Format

Bytes	Frame
1	STX
2	Address
3	WSD
1	,
2	OK
2	SUM
1	CR
1	LF

ex) Writing to D-Registers from ALT1(D0401) to ALT3(D0403)

- Sending Frame : [stx]01WSD,03,0401,0000,0000,0000[cr][lf]
- Sending Frame (Check Sum) : [stx]01WSD,03,0401,0000,0000,000093[cr][lf]

② WRD Command

- WRD Command is used to write data to D-Registers randomly. It is necessary to set the number of registers and the pairs of address and data.

Frame Format

Bytes	Frame
1	STX
2	Address
3	WRD
1	,
2	number
1	,
4	D-Register_1
1	,
4	Data_1
1	,
...	...
1	,
4	D-Register_n
1	,
4	Data_n
2	SUM
1	CR
1	LF

1~32 ————

D-Register address ————

16bit Word (4 character) ————

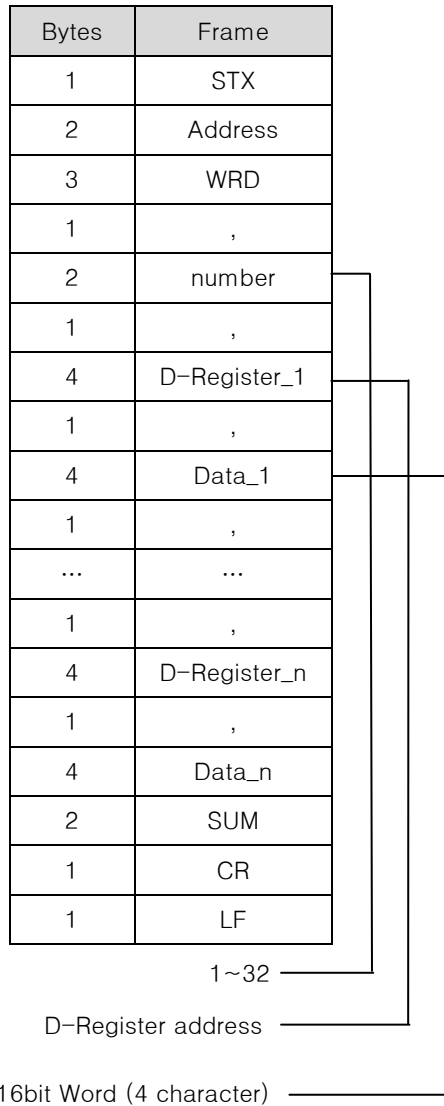

Normal Response Format

Bytes	Frame
1	STX
2	Address
3	WRD
1	,
2	OK
2	SUM
1	CR
1	LF

ex) Writing data to ALT1 (D0401) and ALT3 (D0403)

- Sending Frame : [stx]01WRD,02,0401,0001,0403,0001[cr][lf]
- Sending Frame (Check Sum) : [stx]01WRD,02,0401,0001,0403,00019A[cr][lf]

5-4-2-3 Monitoring Command

① STD Command

- STD Command is used to set the addresses of the D-Registers to monitor. It is necessary to set

the number of registers, and array of addresses.

- To read data of the registers set by STD command, CLD command is used.
- ※ The register list set by STD vanishes when the controller power is OFF. It is necessary to use STD command to use CLD command after power recovery.

Frame Format

Bytes	Frame
1	STX
2	Address
3	STD
1	,
2	number
1	,
4	D-Register_1
1	,
...	...
1	,
4	D-Register_n
2	SUM
1	CR
1	LF

1~32
D-Register

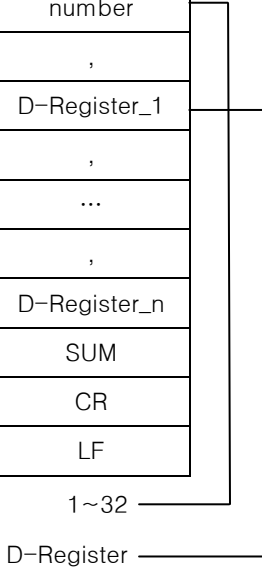

Normal Response Format

Bytes	Frame
1	STX
2	Address
3	STD
1	,
2	OK
2	SUM
1	CR
1	LF

ex) Setting PV(D0001) and SP(D0002) to monitor

- Sending Frame : [stx]01STD,02,0001,0002[cr][lf]
- Sending Frame (Check Sum) : [stx]01STD,02,0001,0002B5[cr][lf]

② CLD Command

- CLD Command is used to read the D-Registers which had been set by STD command.

ex) Reading D-Registers which had been set by STD Command

- Sending Frame : [stx]01CLD[cr][lf]
- Sending Frame (Check Sum) : [stx]01CLD34[cr][lf]

Frame Format

Bytes	Frame
1	STX
2	Address
3	CLD
2	SUM
1	CR
1	LF

Normal Response Format

Bytes	Frame
1	STX
2	Address
3	CLD
1	,
2	OK
1	,
4	Data_1
1	,
...	...
1	,
4	Data_n
2	SUM
1	CR
1	LF

16bit Word (4 character)

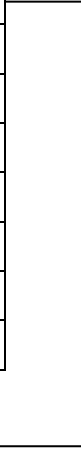

5-4-3 Information Command

- Information Command is used to get the controller information.

Frame Format

Bytes	Frame
1	STX
2	Address
3	AMI
2	SUM
1	CR
1	LF

Normal Response Format

Bytes	Frame
1	STX
2	Address
3	AMI
1	,
2	OK
1	,
10	Model(Size)
1	SPACE
7	Version-Revision
2	SUM
1	CR
1	LF

ex) Getting the controller information, Model, size, version.

- Sending Frame : [stx]01AMI[cr][lf]
- Sending Frame (Check Sum) : [stx]01AMI38[cr][lf]

- Receiving Frame : [stx]01AMI,OK,SP541:4848[sp]V00-R00[cr][lf]
- Receiving Frame (Check Sum) : [stx]01AMI,OK,SP541:4848[sp]V00-R002E[cr][lf]

5-4-4 Error Code

- On Error while communicating, NOVA Series sends a frame as following.

Error Response Frame

Bytes	1	2	2	2	2	1	1
Frame	STX	Address	NG	Error Code	SUM	CR	LF

Error Code	Description	Remark
01	Invalid Command	
	Invalid Register address	
	Data Error	Invalid character in Data string (0~9, A~F hexadecimal digit)
	Error in Format	- Mismatching Command and Format - Number, Number of Data
	Monitoring Command Error	No Monitoring Command
	Time Out Error	Timeout : no termination character for 30 sec after [stx].
11	Check Sum Error	
00	Other Error	

ex) When using an invalid command

- Sending Frame : [stx]01RSF,03,0001[cr][lf]
- Sending Frame (Check Sum) : [stx]01RSF,03,0001C8[cr][lf]

- Receiving Frame : [stx]01NG01[cr][lf]
- Receiving Frame (Check Sum) : [stx]01NG0157[cr][lf]

5-5. MODBUS Protocol

- NOVA의 MODBUS communication has two modes, ASCII(COM.P = '2') and RTU(COM.P = '3').

① Factors of MODBUS

Item	ASCII	RTU
Start of text	: (colon)	none
End of text	CR+LF	None
Data length	7-bit (fixed)	8-bit (fixed)
Data Type	ASCII	Binary
Error Detection	LRC (Longitudinal Redundancy Check)	CRC-16 (Cyclic Redundancy Check)
Data Interval	Less than 1 second	Max. 24-bit time

② Frame Structure

▪ MODBUS ASCII

Start character	Comm. address	Function code	Data	CRC Check	End character
1 char.	2 char.	2 char.	n char.	2 char.	2 char. (CR+LF)

▪ MODBUS RTU

Start character	Comm. address	Function code	Data	CRC Check	End character
none	8-bit	8-bit	N*8-bit	16-bit	None

5-5-1 Function Code

- NOVA provides MODBUS function codes to read/write D-Register and to detect Loop-Back.

Function code	Function
03	D-Register sequential Read
06	Single D-Register Write
08	Diagnostics(Loop-Back Test)
16	D-Register sequential Write

5-5-1-1 Function code - 03

- To read the data of successive D-Register block up to 32 registers.

▪ Frame Format

Factor	ASCII	RTU
Start character	: (colon)	None
Communication address	2 characters	8-bit

Function code – 03	'03' 2 characters	8-bit
D-Register Hi	2 characters	8-bit
D-Register Lo	2 characters	8-bit
Number of reg. Hi	2 characters	8-bit
Number of reg. Lo	2 characters	8-bit
Error detection	2 characters	16-bit
End character	2 characters (CR+LF)	none

▪ Response Format

Factor	ASCII	RTU
Start character	: (colon)	none
Communication address	2 characters	8-bit
Function code – 03	'03' 2 characters	8-bit
Byte Count	2 characters	8-bit
Data-1 Hi	2 characters	8-bit
Data -1 Lo	2 characters	8-bit
...
Data -n Hi	2 characters	8-bit
Data -n Lo	2 characters	8-bit
Error Detection	2 characters	16-bit
End character	2 characters (CR+LF)	none

5-5-1-2 Function code – 06

- To write to single D-Register.

▪ Frame Format

Factor	ASCII	RTU
Start character	: (colon)	None
Communication address	2 characters	8-bit
Function code – 06	'06' 2 characters	8-bit
D-Register Hi	2 characters	8-bit
D-Register Lo	2 characters	8-bit
Write Data Hi	2 characters	8-bit
Write Data Lo	2 characters	8-bit
Error Detection	2 characters	16-bit
End character	2 characters (CR+LF)	None

- Response Format

Factor	ASCII	RTU
Start character	: (colon)	none
Communication address	2 characters	8-bit
Function code – 06	'06' 2 characters	8-bit
D-Register Hi	2 characters	8-bit
D-Register Lo	2 characters	8-bit
Write Data Hi	2 characters	8-bit
Write Data Lo	2 characters	8-bit
Error Detection	2 characters	16-bit
End character	2 characters (CR+LF)	none

5-5-1-3 Function code – 08

- Function code – 08 is used for self-diagnosis.

- Frame Format

Factor	ASCII	RTU
Start character	: (colon)	None
Communication address	2 characters	8-bit
Function code – 08	2 characters	8-bit
Diagnosis code Hi	2 characters	8-bit
Diagnosis code Lo	2 characters	8-bit
Data Hi	2 characters	8-bit
Data Lo	2 characters	8-bit
Error Detection	2 characters	16-bit
End character	2 characters (CR+LF)	None

- Response Format

Factor	ASCII	RTU
Start character	: (colon)	None
Communication address	2 characters	8-bit
Function code – 08	2 characters	8-bit
Diagnosis code Hi	2 characters	8-bit
Diagnosis code Lo	2 characters	8-bit
Data Hi	2 characters	8-bit

Data Lo	2 characters	8-bit
Error Detection	2 characters	16-bit
End character	2 characters (CR+LF)	None

※ Diagnosis code

Code	Description
:	Loop-Back Test : Received Frame Return

5-5-1-4 Function code - 16

- To write data to successive D-Register block up to 16 registers.
- Frame Format

Factor	ASCII	RTU
Start character	: (colon)	None
Communication address	2 characters	8-bit
Function code - 16	'10' 2 characters	8-bit
D-Register Hi	2 characters	8-bit
D-Register Lo	2 characters	8-bit
Number of reg. Hi	2 characters	8-bit
Number of reg. Lo	2 characters	8-bit
Data Bytes	2 characters	8-bit
Data-1 Hi	2 characters	8-bit
Data-1 Lo	2 characters	8-bit
...
Data-n Hi	2 characters	8-bit
Data-n Lo	2 characters	8-bit
Error Detection	2 characters	16-bit
End character	2 characters (CR+LF)	None

- Response Format

Factor	ASCII	RTU
Start character	: (colon)	None
Communication address	2 characters	8-bit
Function code - 16	2 characters	8-bit
D-Register Hi	2 characters	8-bit
D-Register Lo	2 characters	8-bit

Number of data Hi	2 characters	8-bit
Number of data Lo	2 characters	8-bit
Error Detection	2 characters	16-bit
End character	2 characters (CR+LF)	None

5-5-2 Error Code

- Error code is returned when an error is in the Frame.
- Frame Format

Factor	ASCII	RTU
Start character	: (colon)	None
Communication address	2 characters	8-bit
Function code	2 characters	8-bit
Error code	2 characters	8-bit
Error Detection	2 characters	16-bit
End character	2 characters (CR+LF)	None

※ Error codes

Error codes	Description
01	Invalid Function code
02	Invalid D-Register address
08	Data number error

※ The causes of No Response

- Overrun, Framing Error, Parity Error, LRC Error, CRC Error
- Wrong communication address
- The time between adjacent characters is longer than 1 sec.
- Broadcast communication mode

5-6. SYNC communication

- A master controller (COM.P='4') sends its operation parameters (Run/Stop, SP) to slave controllers (COM.P='5') periodically and the operation of slaves are synchronized with that of the master controller. Maximum 31 controllers can be networked.

5-6-1 SYNC-Master

① SYNC-Master Model

- SP and ST Models can be set to SYNC-Master.

② Transmission Frame

SYNC, a, b, c[CR][LF]

Factor	Description
A	STOP(0)/RUN(1)
B	Current SP value including decimal point if any.
c	Check Sum

5-6-2 SYNC-Slave

① SYNC-Slave Model

- ST series can be set to SYNC-Master.

② SYNC-Slave Setting

- COM.P = '5' in G.COM and SPSL = 'RSP' in G.SP.

※ There is no response frame. Slaves do not send response frame.

5-7. D-Register Map

- D-Registers are provided for checking status of the controller. Basically, they are grouped by 100 addresses.

D-Register	Group name	Description	Read	Write
D0000~D0099	PROCESS	Basic parameters	○	○
D0100~D0199	FUNCTION	Operation and functions	○	○
D0200~D0299	SET POINT	SP setting	○	○
D0300~D0399	SIGNAL	Inner Signal	○	○
D0400~D0499	ALARM	Alarm setting	○	○
D0500~D0599	PID	P.I.D	○	○
D0600~D0699	IN/OUT	Input and Output	○	△
D0700~D0799	RESERVED	Reserved	X	X
D0800~D0899	RESERVED	Reserved	X	X
D0900~D0999	RESERVED	Reserved	X	X
D1000~D1099	PT INFO	Program Pattern Info.	○	○
D1100~D1199	PT1	Program Pattern Setting	○	○
D1200~D1299	PT2	Program Pattern Setting	○	○
D1300~D1399	RESERVED	Reserved	X	X

5-7-1 Process

- Process Group includes the basic information of operating. The detailed Bit-Map information of status registers is described at the end of this manual.

D-Register	Symbol	Description
D0001	NPV	Current PV
D0002	NSP	Current SP
D0003	TSP	Target Set Point
D0006	MVOUT	Control output
D0009	PIDNO	P.I.D Number being used
D0010	NOWSTS	Current operation status
D0014	ALSTS	Current alarm status
D0015	EVSTS	Current event status
D0017	SIGNAL.STS	Current signal status
D0019	ERROR	Current error status
D0025	PTNO	Current Pattern being used
D0026	SEG.NO	Current segment

D0027	END.SEG.NO	Last segment number of current pattern
D0028	RUN.TIME	Time processed in the segment
D0029	SET.TIME	The segment time of the segment
D0030	HB.CD	Heater current display
D0031	LINK.CODE	Link code at pattern end
D0032	RPT	Number of segments repeating from RST to REN
D0033	RST	Start segment of repeating block
D0034	REN	End segment of repeating block
D0036	WAIT.TIME	Waiting time

5-7-2 Function

- Function Group is related with operation and settings.

D-Register	Symbol	Description
D0111	F.KEY, RST/P1/P2	Pattern selection
D0112	HOLD, OFF/ON	Hold on/off of current segment
D0113	STEP, OFF/ON	Move to the next segment
D0121	AT	Auto Tuning on
D0122	AT-G	PID gain
D0133	PE-TM	Duration of pattern end signal out
D0135	US1	User screen 1
D0136	US2	User screen 2
D0137	LOCK	If Lock on, parameter setting is blocked.
D0138	DI.SL	Select mapping mode of DI and operation
D0139	DSP.H	High limit of PV display
D0140	DSP.L	Low limit of PV display
D0144	U.KEY	User defined Key

5-7-3 Set Point

- Set Point group is related with SP setting.

D-Register	Symbol	Description
D0205	HOLD_SP	SP HOLD
D0206	HOLD_TM	HOLD Setting Time

5-7-4 Signal

- Signal Group is related with Inner Signal.

D-Register	Symbol	Description
D0301	1.IST	Type of Inner Signal1
D0302	1.ISB	Inner Signal1 direction (in-band, out-of-band)
D0303	1.ISH	High limit of the Inner Signal1 band
D0304	1.ISL	Low limit of the Inner Signal1 band
D0305	1.ISD	Delay time of Inner Signal1 output
D0306	2.IST	Type of Inner Signal2
D0307	2.ISB	Inner Signal2 direction (in-band, out-of-band)
D0308	2.ISH	High limit of the Inner Signal2 band
D0309	2.ISL	Low limit of the Inner Signal2 band
D0310	2.ISD	Delay time of Inner Signal2 output

5-7-5 Alarm

- Alarm group is related with alarm setting.

D-Register	Symbol	Description
D0401	ALT1	Type of Alarm-1
D0402	ALT2	Type of Alarm-2
D0403	ALT3	Type of Alarm-3
D0406	AL-1	Alarm point of Alarm-1
D0407	AL-2	Alarm point of Alarm-2
D0408	AL-3	Alarm point of Alarm-3
D0411	A1.DB	Dead Band of Alarm-1
D0412	A2.DB	Dead Band of Alarm-2
D0413	A3.DB	Dead Band of Alarm-3
D0416	A1.DY	Delay time of Alarm-1 output
D0417	A2.DY	Delay time of Alarm-2 output
D0418	A3.DY	Delay time of Alarm-3 output
D0421	AL1.H	High limit of deviation (Alarm-1)
D0422	AL2.H	High limit of deviation (Alarm-2)
D0423	AL3.H	High limit of deviation (Alarm-3)
D0426	AL1.L	Low limit of deviation (Alarm-1)
D0427	AL2.L	Low limit of deviation (Alarm-2)
D0428	AL3.L	Low limit of deviation (Alarm-3)

D0432	HB.CS	Heater break current setting
D0433	HB.DB	Dead band of Heater break alarm

5-7-6 PID

- PID group is related with PID setting.

D-Register	Symbol	Description
D0501	ARW	Deviation band for ARW function
D0502	FUZZY	FUZZY function on/off
D0503	C.MOD	PID control mode (D.DV, D.PV)
D0511	1.P	Proportional band of PID1 set
D0512	1.I	Integration time of PID1 set
D0513	1.D	Derivation time of PID1 set
D0514	1.MR	Manual reset value of integration time when 1.I = 0
D0519	1.RP	Zone boundary between PID1 and PID2
D0521	2.P	Proportional band of PID2 set
D0522	2.I	Integration time of PID2 set
D0523	2.D	Derivation time of PID2 set
D0524	2.MR	Manual reset value of integration time when 2.I = 0
D0529	2.RP	Zone boundary between PID2 and PID3
D0531	3.P	Proportional band of PID3 set
D0532	3.I	Integration time of PID3 set
D0533	3.D	Derivation time of PID3 set
D0534	3.MR	Manual reset value of integration time when 3.I = 0
D0539	RP.HY	Hysteresis at PID Zone boundary
D0541	4.P	Proportional band of PID4 set
D0542	4.I	Integration time of PID4 set
D0543	4.D	Derivation time of PID4 set
D0544	4.MR	Manual reset value of integration time when 4.I = 0
D0549	RDV	Deviation when using deviation PID

5-7-7 IN/OUT

- IN/OUT group is related with input and control output.

D-Register	Symbol	Description
D0601	IN-T	Sensor Input type
D0602	IN-U	Temperature unit of '°C' and '°F'

D0603	IN.RH	High limit of sensor input
D0604	IN.RL	Low limit of sensor input
D0605	IN.DP	Decimal point of PV
D0606	IN.SH	Input scale high limit
D0607	IN.SL	Input scale low limit
D0608	IN.FL	PV Filter
D0609	B.SL	Burn-out mode selection
D0610	R.SL	RJC selection
D0611	BSP1	PV Bias point 1
D0612	BSP2	PV Bias point 2
D0613	BSP3	PV Bias point 3
D0615	BS0	PV Bias at IN.RL
D0616	BS1	PV Bias at BSP1
D0617	BS2	PV Bias at BSP2
D0618	BS3	PV Bias at BSP3
D0619	BS4	PV Bias at IN.RH
D0621	AL.BS	PV display offset value in all range
D0622	D.FL	PV display filter
D0624	OUT1	OUT1 type (4~20mA, PULSE) of HEAT, RET
D0625	OUT2	OUT2 type (4~20mA, PULSE) of HEAT, RET
D0627	EV1	EVENT1 Output
D0628	EV2	EVENT2 Output
D0629	EV3	EVENT3 Output
D0631	HEAT1	OUT1(Heating) type of SSR, SCR
D0633	HEAT2	OUT2(Heating) type of SSR, SCR
D0637	O.ACT	Control Direction (Forward, Reverse)
D0638	CT	The cycle time of SSR or Relay control
D0641	OH	High limit of MV output
D0642	OL	Low limit of MV output
D0646	PO	Preset Output
D0651	RET	Retransmission type of PV, SP, MV
D0652	RETH	High limit of retransmission
D0653	RETL	Low limit of retransmission
D0655	OPR	MV change rate %/sec
D0657	O.LED	MV out lamp display type of SSR, SCR

D0661	COM.P	Communication Protocol
D0662	BAUD	Baud Rate
D0663	PRTY	Parity
D0664	SBIT	Stop Bit
D0665	DLEN	Data Length
D0666	ADDR	Address
D0667	RP.TM	Response Time

5-7-8 PT_Info

- PT_Info Group is related with program run.

D-Register	Symbol	Description
D1001	TMU	Time unit
D1002	STC	Program start mode of PV, SSP
D1003	W.ZON	Waiting zone
D1004	W.TM	Wait time

5-7-8 PT1/PT2

- PT1/PT2 group is related with pattern setting.

D-Register	Symbol	Description
D1101	1.LC	Next link after pattern end point
D1102	1.SSP	Starting SP
D1104	1.SP1	Target SP of Segment-1
D1105	1.TM1	Run time of Segment-1
D1106	1.TS1	Time signal action in Segment-1
...
D1146	1.SPF	Target SP of Segment-1
D1147	1.TMF	Run time of Segment-1
D1148	1.TSF	Time signal action in Segment-1
D1151	1.RPT	Repetition number of segment block
D1152	1.RST	The first segment of repeating block
D1153	1.REN	The last segment of repeating block

※ the content of Pattern-2(PT2) is the same as Pattern-1(PT1).

※ D-Register 0000~0499

NO	PROCESS	FUNCTION	SET POINT	SIGNAL	ALARM
	0	100	200	300	400
0					
1	NPV			1.IST	ALT1
2	NSP			1.ISB	ALT2
3	TSP			1.ISH	ALT3
4				1.ISL	
5			HOLD-SP	1.ISD	
6	MVOUT		HOLD-TM	2.IST	AL-1
7				2.ISB	AL-2
8				2.ISH	AL-3
9	PIDNO			2.ISL	
10	NOWSTS			2.ISD	
11		F.KEY. RST/P1/P2			A1DB
12		HOLD, OFF/ON			A2DB
13		STEP, OFF/ON			A3DB
14	ALSTS				
15	EVSTS				
16					A1DY
17	SIGNAL.STS				A2DY
18					A3DY
19	ERROR				
20					
21		AT			AL1.H
22		AT-G			AL2.H
23					AL3.H
24					
25	PTNO				
26	SEG.NO				AL1.L
27	END.SEG.NO				AL2.L
28	RUN.TIME				AL3.L
29	SET.TIME				
30	HB.CD				SK.DV
31	LINK.CODE				
32	RPT				HB.CS
33	RST	PE-TM			HB.DB
34	REN				
35		US1			
36	WAIT.TIME	US2			
37		LOCK			
38		DI.SL			
39		DSP.H			
40		DSP.L			
41					
42					
43					
44		U.KEY			
45					
46					
47					
48					
49					
50	User Area				
51					
52					
53					
54					

55				
56				
57				
58				
59				
60				
61				
62				
63				
64				
65				
66				
67				
68				
69				
70				
71				
72				
73				
74				
75				
76				
77				
78				
79				
80				
81				
82				
83				
84				
85				
86				
87				
88				
89				
90				
91				
92				
93				
94				
95				
96				
97				
98				
99				

※ D-Register 0500~0999

NO	PID	IN/OUT	RESERVED	RESERVED	RESERVED
	500	600	700	800	900
0					
1	ARW	IN-T			
2	FUZZY	IN-U			
3	C.MOD	IN.RH			
4		IN.RL			
5		IN.DP			
6		IN.SH			
7		IN.SL			
8		IN.FL			
9		B.SL			
10		R.SL			
11	1.P	BSP1			
12	1.I	BSP2			
13	1.D	BSP3			
14	1.MR				
15		BS0			
16		BS1			
17		BS2			
18		BS3			
19	1.RP	BS4			
20					
21	2.P	AL.BS			
22	2.I	D.FL			
23	2.D				
24	2.MR	OUT1			
25		OUT2			
26					
27		EV1			
28		EV2			
29	2.RP	EV3			
30					
31	3.P	HEAT1			
32	3.I				
33	3.D	HEAT2			
34	3.MR				
35					
36					
37		O.ACT			
38		CT			
39	RP.HY				
40					
41	4.P	OH			
42	4.I	OL			
43	4.D				
44	4.MR				
45					
46		PO			
47					
48					
49	RDV				
50					
51		RET			
52		RET.H			
53		RET.L			
54					
55		OPR			

56					
57		O.LED			
58					
59					
60					
61		COM.P			
62		BAUD			
63		PRTY			
64		SBIT			
65		DLEN			
66		ADDR			
67		RP.TM			
68					
69					
70					
71					
72					
73					
74					
75					
76					
77					
78					
79					
80					
81					
82					
83					
84					
85					
86					
87					
88					
89					
90					
91					
92					
93					
94					
95					
96					
97					
98					
99					

※ D-Register 1000~1399

NO	PT INFO	PT1	PT2	RESERVED
	1000	1100	1200	1300
0				
1	TMU	1.LC	2.LC	
2	STC	1.SSP	2.SSP	
3	W.ZON			
4	W.TM	1.SP1	2.SP1	
5		1.TM1	2.TM1	
6		1.TS1	2.TS1	
7		1.SP2	2.SP2	
8		1.TM2	2.TM2	
9		1.TS2	2.TS2	
10		1.SP3	2.SP3	
11		1.TM3	2.TM3	
12		1.TS3	2.TS3	
13		1.SP4	2.SP4	
14		1.TM4	2.TM4	
15		1.TS4	2.TS4	
16		1.SP5	2.SP5	
17		1.TM5	2.TM5	
18		1.TS5	2.TS5	
19		1.SP6	2.SP6	
20		1.TM6	2.TM6	
21		1.TS6	2.TS6	
22		1.SP7	2.SP7	
23		1.TM7	2.TM7	
24		1.TS7	2.TS7	
25		1.SP8	2.SP8	
26		1.TM8	2.TM8	
27		1.TS8	2.TS8	
28		1.SP9	2.SP9	
29		1.TM9	2.TM9	
30		1.TS9	2.TS9	
31		1.SPA	2.SPA	
32		1.TMA	2.TMA	
33		1.TSA	2.TSA	
34		1.SPB	2.SPB	
35		1.TMB	2.TMB	
36		1.TSB	2.TSB	
37		1.SPC	2.SPC	
38		1.TMC	2.TMC	
39		1.TSC	2.TSC	
40		1.SPД	2.SPД	
41		1.TMD	2.TMD	
42		1.TSD	2.TSD	
43		1.SPE	2.SPE	
44		1.TME	2.TME	
45		1.TSE	2.TSE	
46		1.SPF	2.SPF	
47		1.TMF	2.TMF	
48		1.TSF	2.TSF	
49				
50				
51		1.RPT	2.RPT	
52		1.RST	2.RST	
53		1.REN	2.REN	
54				
55				

56				
57				
58				
59				
60				
61				
62				
63				
64				
65				
66				
67				
68				
69				
70				
71				
72				
73				
74				
75				
76				
77				
78				
79				
80				
81				
82				
83				
84				
85				
86				
87				
88				
89				
90				
91				
92				
93				
94				
95				
96				
97				
98				
99				

※ BIT-MAP Information

NO	NOW STATUS (D0010)	ALARM STATUS (D0014)	SIGNAL STATUS (D0017)	ERROR STATUS (D0019)
0		ALARM1	IS1	SYS.ERR
1		ALARM2	IS2	
2		ALARM3	TS	
3				
4	RESET	EVENT1		AD.ERR
5	PROG1	EVENT2		
6	PROG2	EVENT3		
7	HOLD			
8	WAIT		UP	+OVER
9			DOWN	-OVER
10			PEND	S.OPN
11				
12	AT			
13				
14				
15				

SAMWONTECH CO.,LTD.
202-703, Buchon Techno-park,
Yakdae-dong, Wonmi-gu, Buchon,
Gyeonggi-do, Korea 420-773
TEL : +82-32-326-9120,9121
FAX : +82-32-326-9119
<http://www.samwontech.com>
E-mail:webmaster@samwontech.com

Further information contact samwontech.

Printed in Korea : Feb. 2008(A)

The contents of this document are subject to change without prior notice.

All Rights Reserved. Copyright © 2008 Samwontech Co.,Ltd.